

IKA

designed for scientists

IKA Calorimeter C 1







Declaration of Conformity

We declare under our sole responsibility that this product is in compliance with the regulations 2014/68/EC (article 3, (3)), 2011/65/EU, 2014/30/EU and 2014/35/EU and conforms to the standards or standardized documents: EN 61010-1, EN 61326-1, EN 60529 and EN ISO 12100.

A copy of the complete EU Declaration of Conformity can be requested at sales@ika.com.

Explication of warning symbols

	Indicates an imminently hazardous situation, which, if not avoided, will result in death, serious injury.
	Indicates a potentially hazardous situation, which, if not avoided, can result in death, serious injury.
	Indicates a potentially hazardous situation, which, if not avoided, can result in injury.
	Indicates practices which, if not avoided, can result in equipment damage.
	Reference to exposure to a hot surface!

User notes

Read the operation instructions completely before starting up and follow the safety instructions.

Keep the operation instructions in a place where they can be accessed by everyone.

Ensure that only trained staff work with the appliance.

Follow the safety instructions, guidelines, occupational health and safety and accident prevention regulations.

In this chapter you can find out how to work through these Operating Instructions most effectively to be able to work reliably with the calorimeter system.

The instructions in the section "Safety instructions" must be complied with.

The chapters are designed for you to work through them in order.

The section "Transport, storage" is relevant for system reliability and for ensuring high measuring accuracy.

The calorimeter system is ready to perform measurements once you have completed the procedures in the section "Setting up and commissioning": - "Preparing a measurement" and "Starting a measurement".

Numbers 1, 2, 3 etc. indicate operating instructions in the following sections. These must always be carried out in the specified sequence.

Warranty and liability

In accordance with **IKA** warranty conditions, the warranty period is 12 months. For claims under the warranty please contact your local dealer. You may also send the machine direct to our factory, enclosing the delivery invoice and giving reasons for the claim. You will be liable for freight costs.

The warranty does not cover worn out parts, nor does it apply to faults resulting from improper use, insufficient care or maintenance not carried out in accordance with the instructions in this operating manual.

Please read these operating instructions carefully. **IKA** only consider themselves to be responsible for the safety, reliability and performance of the appliance when

- the appliance has been operated in accordance with the operating instructions,
- only persons authorised by the manufacturer interfere with the appliance,
- only original parts and original accessories are used for repairs.

The calorimeter system may be opened only by an authorised Service Agent or Customer Service Centre.

If service is required, we recommend that you contact our customer service department. Furthermore, we refer you to the applicable safety conditions and accident requirements.

IKA is not responsible for damages or costs resulting from accident, improper use of the device or impermissible modifications, repairs or renovations.

Contents

	Page		Page
Declaration of Conformity	02	Measurements	25
Explication of warning symbols	02	New measurements	25
User notes	02	Last result	25
Contents	03	System test	26
Safety instructions	04	Measurement archive	26
Correct use	05	Measurement archive: Edit	27
System properties	05	Measurement archive: Print	27
Transportation, Storage	06	Measurement archive: Delete	27
Transport and Storage conditions	06	Measurement archive: Delete all	28
Unpacking	06	Calibration archive	28
Scope of delivery	06	Calibration archive: Edit	28
Description of the system components	06	Calibration archive: C-Value selectin	29
Hoses	07	Calibration archive: Print	29
Commissioning	07	Calibration archive: Delete	29
Place of installation	07	Default settings	30
Cooler connection	08	Settings	30
Venting hose connection	08	Date / Time	30
Drain hose connection	08	Units	30
Oxygen supply connection	08	Display / Keypad	31
Power supply unit connection	09	Inverted menu view	31
Connection of peripherals	09	List view	31
Handling the unit	09	Language	31
Control unit with display	10	Accessories	32
Dialog box	11	Chiller test	32
System start	12	Maintenance	32
Switching on the system (in the open state)	12	Maintenance menu	32
Selection of language	12	Change seal	33
Pressure test	13	Stirrer test	33
Oxygen pressure	13	O ₂ System blow	33
System check	13	Servo up	33
Heating detected	14	Servo down	33
Factory settings	14	Informations	33
Calorimetric measurements	14	User information: Memory	34
Determination of gross calorific value	14	Prior to input a new measurement	34
Corrections	15	After input a new measurement	34
Notes on the sample	15	Exchanging off wear parts	34
Complete combustion	16	O ₂ Valve seal change	34
Calibration	16	Change ignition wire	35
Notes on calibration	16	Change ignition electrode	35
Overview Main menu	17	Change the main seal	35
Measurements	17	Change ground electrode	36
Default settings	17	Leak test with the system test	36
Settings	17	Fault and troubleshoot	36
Maintenance	18	E01 STIRRER	36
Informations	18	E02 COMMUNICATION	37
Preparing and performing measurements	18	E03 DRIFT ALARM	37
Performing the measurement	18	E04 MINTEMPDIF	37
Placing the sample	19	E05 FILLWATER	37
Preparing a measurement	20	E06 EMPTYWATER	38
Close the calorimeter	20	E07 POSTWATERFILLING	38
Prerequisite checking for a measurement	21	E10 FILLWATER SENSOR	38
Measurement procedure	21	E11 SYSTEM OPEN	38
Cleaning the inner vessel	23	E12 PRESSURE	38
Follow-up measurement	23	E13 HEATER	39
Display the storage overview	23	E16 MAXTEMPDIFF	39
Use of a disposable crucible	23	Accessories and Consumables	39
Using a scale	24	Maintenance	40
Permissible weight entries	24	Warranty	40
Cancel a measurement	25	Technical data	41

Safety instructions



Read the operating instructions in full before starting up and follow the safety instructions.

Keep the operating instructions in a place where they can be accessed by everyone.

Ensure that only trained staff work with the appliance.

The calorimeter C 1 may only be used for the determination of calorific value of solid and liquid materials according to national and international standards (eg DIN 51900, BS 1016 T5, ISO 1928, ASTM 5468, ASTM 5865 and ASTM 4809).

The pressure vessel is integrated into the calorimeter C 1. The maximum extra energy added to the pressure vessel must not exceed **40,000 J** (select the test mass accordingly). The permitted operating pressure of **142 bar (14.2 MPa)** must not be exceeded. The maximum permitted operating temperature must not exceed **50 °C**.

Only fill calorimeter system C 1 with oxygen to a maximum pressure of **40 bar (4 MPa)**. Check the pressure setting on the pressure reducer for your oxygen supply. Perform a leakage test before each combustion process (see section "Leaktightness testing with system test").

Some materials tend to explode when combusted (e.g. due to formation of peroxides), which could cause the decomposition vessel to crack. **The IKA C 1 calorimeter may not be used for testing explosive samples.**

If the burning behaviour of a material is unknown, it must be tested before combustion in the inner vessel (risk of explosion). If you are burning **unknown samples**, leave the room or **keep your distance** from the calorimeter.

Benzoic acid may only be combusted in its pressed form! Flammable dust and powder must be first pressed. Oven-dry dust and powder such as splints, hay, straw etc. explode when combusted! Always wet these materials first! Highly flammable liquids with a low vapour pressure (e.g. tetramethyl dihydrogen disiloxane) must not directly touch the cotton thread!

Please pay attention to the combustion of metal-containing substances, that the permissible total energy input is not exceeded! Furthermore, toxic combustion residue in the form of gases, ashes or condensation, for example, is possible in the inner wall of the inner vessel.

Observe the accident prevention requirements applicable to the activity and the work station.

Wear your personal protective equipment.



DANGER **When handling combustion samples, combustion residue and auxiliary materials, please observe the relevant safety regulations.**

The following materials, for example, could pose a risk:

- corrosive
- highly flammable
- explosive
- bacteriologically contaminated
- toxic.

Please observe the relevant regulations when handling oxygen.

Warning: oxygen as a compressed gas is oxidising; intensively aids combustion; can react violently with flammable materials.

Do not use oil or grease!

Tubes and screwed joints for oxygen must be kept free of grease.



DANGER

Combustion gases are hazardous to health, therefore the venting hose must be connected to a suitable gas cleaning system or extraction system.



DANGER

Caution! In case of failure Error 04 "Min.Temp.Diff." the combustion chamber could be hot after an ignition/combustion, even though the message "No temperature increase!" is displayed.

At the end of the work period, close the main valve for the oxygen supply.

Perform servicing work only when the equipment is depressurised.

When using stainless steel crucibles thoroughly check their condition after each experiment.

If the material gets thinner, the crucible may catch fire and damage the pressure vessel. **Crucibles must not be used for more than 25 combustions for safety reasons.**

The EC Declaration of Conformity confirms that this pressure vessel was manufactured by the Pressure Equipment Directive 2014/68/EC. (Article 3, paragraph 3).

The pressure vessel has undergone a pressure test with test pressure of **203 bar (20.3 MPa)** and a leakage test with oxygen at **40 bar**.

Decomposition vessels are experiment autoclaves and must be tested by a technical expert after each use. (see capture: "Maintenance").

Individual use is understood here to include a series of experiments performed under roughly the same conditions in terms of pressure and temperature. Experiment autoclaves must be operated in special chambers.

The pressure vessels must undergo repeated tests (internal tests and pressure tests) performed by the technical expert. The frequency of these tests is to be determined by the operator on the basis of experience, type of operation and the material used in the pressure vessel.

The declaration of conformity becomes invalid if mechanical modifications are carried out to the experiment autoclaves or if tightness can no longer be guaranteed as a result of major corrosion (e.g. pitting by halogens).

In particular the Thread on the lower part of the pressure vessel and the nut are subject to considerable stress and must therefore be checked regularly for wear. (see figure "Description of the system components").

The condition and function of the seals must be checked and ensured by way of a system test (see capture "system check").

Check the seals for damage before each use (see chapter "Maintenance").



DANGER

If the maintenance, and especially the pressure testing, is not performed or is performed incorrectly, there is a risk the decomposition vessel may burst or an uncontrolled internal fire may occur at the electrodes which could burn away the seals (oxyacetylene torch effect), thus posing a risk to life and limb!

Only technical experts may perform pressure tests and service work on the decomposition vessel.

We recommend that you send the C 1 calorimeter system to our factory for inspection, and if necessary, repair after 1000 tests or after one year or sooner depending on use.

For the purposes of these operating instructions a technical expert is someone

1. who guarantees to conduct the tests properly on the basis of his training, knowledge and experience gained through practical work,
2. who is sufficiently reliable,
3. who is not subject to any instructions in terms of the test activity,
4. who has suitable test equipment if necessary,
5. who can provide appropriate proof of the requirements listed in 1.

Correct use

The **IKA C 1** calorimeter system is used for calorific value determination of solid and liquid substances.

This is done by placing a known quantity of a substance in a decomposition vessel which is surrounded by a water jacket. The sample is then combusted in an oxygen atmosphere. The calorific value of the sample can then be calculated from the resulting increase in temperature, the sample mass and the known thermal capacity of the overall system.

The C 1 calorimeter system is subject to the Pressure Vessel Directive 2014/68/EC. Comply with the safety instructions accordingly.

For adaptation to individual laboratory tasks, use original **IKA** consumables and accessories.

System properties

The **IKA C 1** calorimeter is a combustion calorimeter for determining gross calorific values of liquid and solid non-explosive substances. The samples were burned at an excess of oxygen under pressure in a closed vessel. The resulting amount of heat, measured in a previously calibrated system, allows the determination of the calorific value of the sample after preliminary various globally applied standards and regulations.

The necessary corrections after combustion in the calorimeter can then, for example, about our CalWin® C 6040 calorimeter software (accessories), from the acid corrections up to the calorific value according to DIN, ISO, ASTM, GB, and GOST standards typed, corrected and calculated. By a transfer of the results to Excel can quickly and easily adapt special or own calculations.

The worldwide unique patented **IKA** calorimeter C 1 operates on the globally applied isoperibolic measurement procedure at 22 °C and 30 °C. The temperature values are output every 12 seconds, and the calculation of the temperature correction according to standards Regnault Pfaundler.

Measurement times of the system:

- Sample preparation time: < 1 minute
- from the start of measurement until the start of the next: 12 minutes
- Pre-experimental period: Response of the system 3 minutes
- Main experiment: after ignition of the sample: 4 minutes

To a supply of cooling water, the calorimeter can with a conventional thermostat / cooler operate for example such as the **IKA KV 600** (accessory).

National directives and laws must be observed for operating pressure vessels!

Anyone operating a pressure vessel must keep it in a proper condition, operate it properly, supervise it, carry out the necessary maintenance and repair work immediately and implement the safety measures required in the circumstances.

A pressure container must not be operated if it exhibits defects that could endanger those working with it or third parties. You can obtain a copy of the pressure vessel regulation from Beuth Press.

Do not use distilled or demineralized water (increased risk of corrosion)!

Fill the cooler according to the cooler operating instructions. Cooling water temperature settings on the thermostat / cooler:

- in mode of operation isoperibol 22 °C: 18–21 °C
- in mode of operation isoperibol 30 °C: 26–29 °C

Alternatively, the device can also be operated via an optionally available heating C 1.20 (accessories) at a fixed water connection. The accessories for connection to the water pipe or the thermostat is contained in the corresponding delivery.

Requirements for the operation of the C 1 with the C 1.20 heating on a water pipe:

- tap water: is recommended in drinking tap water quality. Mix in (max. 1 ml for 4-5 l of water) of the supplied water additive. Thus, the durability of the water is improved.
- temperature range: 12 °C – 28 °C (according to the water temperature, the measuring mode 22 °C or 30 °C must be selected).
- water pressure: max. 1 – 1.5 bar (at higher or constant pressure, we recommend using the C 25 water pressure regulating valve available as an accessory)
- water consumption per measurement: about 4 liters

Automatic internal system checks enable the identification and monitoring

- the presence of oxygen pressure
- the controlled stirrer speed
- the the availability of water in the system
- the input water temperature
- of inner vessel
- the correct shutter of the measuring cell with locking
- Ignition counter with memory function for the next due maintenance

Transportation, Storage

Transport and Storage conditions

The system must be protected against mechanical impact, vibrations, dust deposits and corrosive ambient air during transportation and storage. It is also important to ensure that the relative humidity does not exceed 80%.

The appliance must be completely emptied before storing and transportation.

In case of repair the device has to be cleaned and free from any materials which may constitute a health hazard.

If you require servicing, return the appliance in its original packaging. Storage packaging is not sufficient. Please also use suitable transport packaging.

Unpacking

Please unpack the system components carefully and check for any damage. When you unpack the equipment, check for any damages which may have occurred during transportation. In the case of any damage a fact report must be sent immediately (post, rail or forwarder).

Scope of delivery

- | | | | |
|--|--|--|--|
| <ul style="list-style-type: none"> • IKA C 1 Calorimeter • Power supply unit • Inflow conduit • Return conduit • Discharge hose • Round cable clamp • Connection tube • Venting hose | <ul style="list-style-type: none"> • Mains cable • 1 Tool • 5 O-ring FPM 11.0 x 2.0 • 2 O-ring FPM 6.0 x 2.0 • 2 O-ring FPM 15.0 x 2.0 • 5 O-ring FPM 10.0 x 2.5 • 5 O-ring FPM 8.0 x 2.5 • 5 O-ring FPM 4.0 x 1.5 | <ul style="list-style-type: none"> • 1 O-ring FPM 3.1 x 1.6 • 5 O-ring FPM 3.0 x 1.5 • 5 O-ring FPM 48.0 x 2.0 • 1 Quad-Ring NBR 92.0 x 4.5 • 1 X-Ring NBR 6,07 x 1,78 • C 1.104 water bath additive • C 723 Benzoic acid • C 1.1012 Organizer | <ul style="list-style-type: none"> • 4 base • O-ring-grease Molykote 55 • Handle • Operating instructions C 1 • Safety instructions C 1/C 6000 • Technical information C 1 • Insert sheet C 1 (4 steps to use) • Warranty card |
|--|--|--|--|

Description of the system components

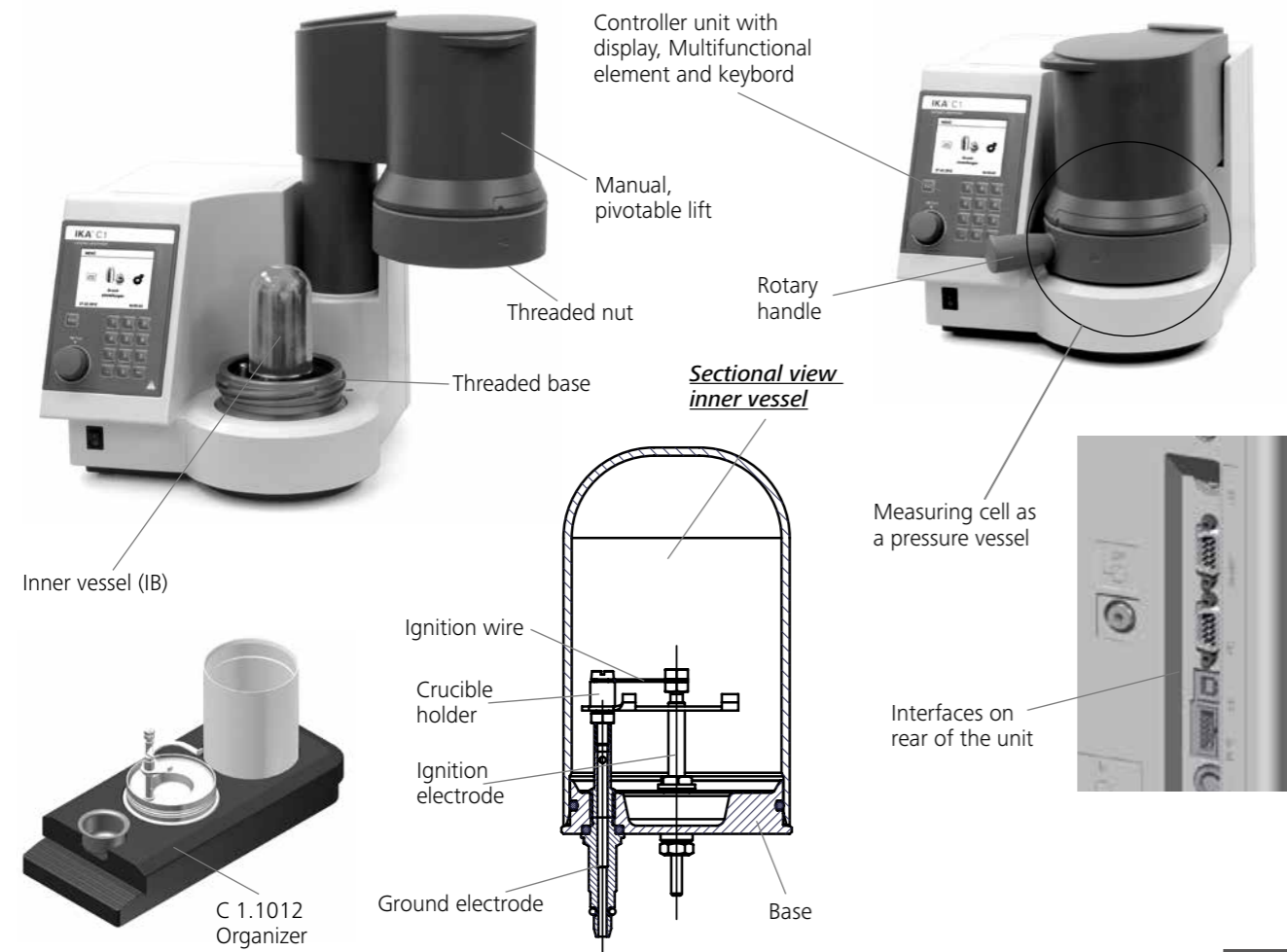

Hoses

- Discharge hose

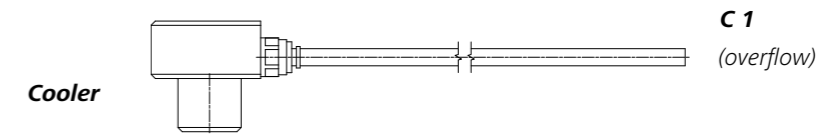

- Inflow conduit

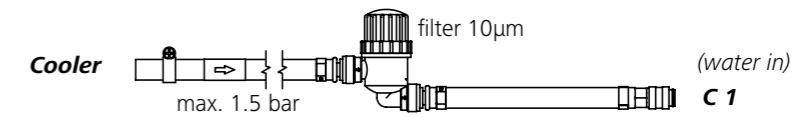

- Return conduit

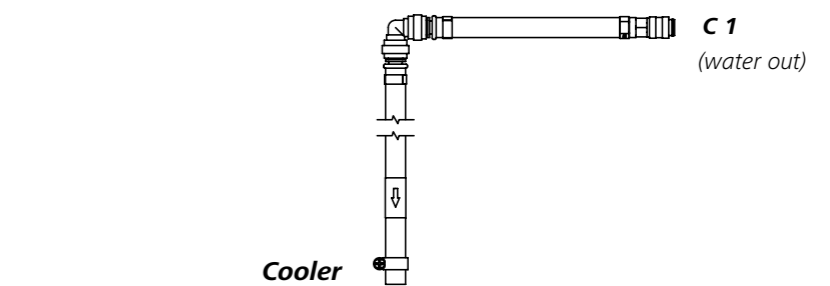

- Venting hose

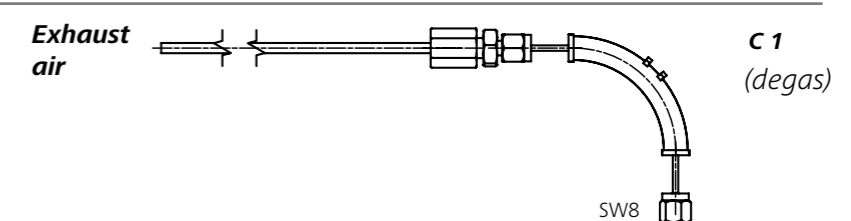

- Connection tube

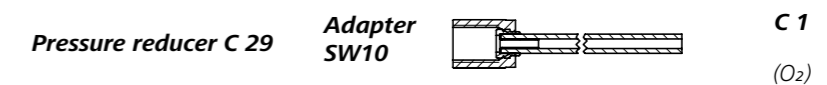

Commissioning

Place of installation

A constant ambient temperature is an important requirement for ensuring the high measuring accuracy of the system. The following conditions must therefore be fulfilled at the place of installation:

- No direct solar radiation
- No draughts (e.g. beside windows, doors, air conditioning)
- Sufficient distance to radiators and other heat sources
- The minimum distance between the wall and the rear side of the device must be at least 25 cm.
- The system must not have laboratory hardware such as shelves, wire ducts, ring lines, etc. installed above it.
- The (constant) room temperature should be around 20 °C ... 25 °C.
- The system must be set up on a horizontal surface.

For operation of the system the following must be available at the place of installation:

- A power supply corresponding to the nameplates on the system components,
- An oxygen supply (99.95 % pure oxygen, quality 3.5; pressure 30 bar) with pressure gauge.

A shut-off valve for the oxygen supply must be installed. Observe the instructions on handling oxygen given in the chapter "Safety instructions".

Observe the instructions on handling oxygen given in the chapter "Safety instructions". Please read these operating instructions carefully. IKA consider themselves responsible for the safety, reliability and performance of the appliance only when

- the device has been operated in accordance with the operating instructions
- the specifications for the place of installation have been met.

Cooler connection

1. Connect the inflow pipe to the quick coupling to the "water in" (on the calorimeter) port. Connect the other end of the radiator side of "water out" and tighten the hose clamp.



Inflow pipe

2. Connect the return pipe to the quick coupling to the "water out" (on the calorimeter) port. Connect the other end to "water in" (on the cooler) and tighten the hose clamp.



Return pipe

Venting hose connection

1. Screw the venting hose to to "degas" screw coupling (SW8; on the calorimeter) and lay the free end in the extractor. Connect the free end to a gas scrubber gadget.



Venting hose

Observe the applicable safety regulations..
The combustion gases are vented from the decompsion vessel after each combustion test on the vent hose. The vent hose must not be kinked or pinched during installation.



Combustion gases are dangerous to health, so the venting hose must be connected to a suitable gas cleaning and extraction.

Drain hose connection

1. Insert the drain hose fully into the "tap-water" connection (on the calorimeter). Lay the other end of the drain hose to the cooler filler neck.



Drain hose

2. Secure the hose end with an attachable adhesive protection.

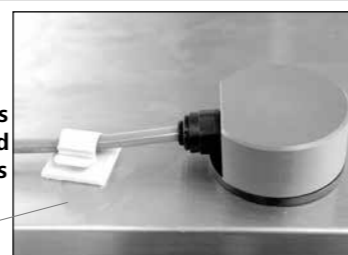

The hose end must always have free access of air and never immerse themselves in the cool water!

Cooler

3. **Do not use distilled or demineralized water (increased risk of corrosion)!** Fill the cooler according to the cooler operating instructions. is recommended in drinking tap water quality. Mix in (max. 1 ml for 4-5 l of water) of the supplied water additive. Thus, the durability of the water is improved..
4. Adjust the cooler temperature corresponding to the calorimeter operating temperature.

Oxygen supply connection

1. Insert the connection tube fully into the coupling ("O₂ in"; on the calorimeter) and connect the free end on the pressure reducer IKA C 29 (possibly with the C 29 adapter, included with)

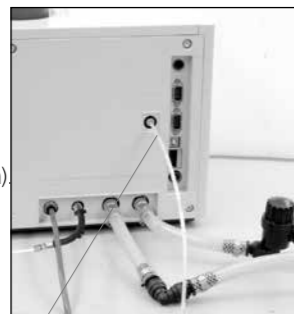

Connection tube allowable operating pressure 40 bar

IKA C 29 Pressure reducer

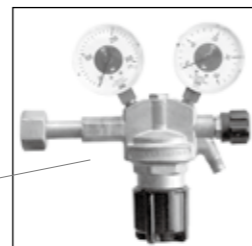

Power supply unit connection

1. Connect the power supply connecting cable (24 V)

NOTE: Note the correct insertion position (flat side of the connector pointing to the right).

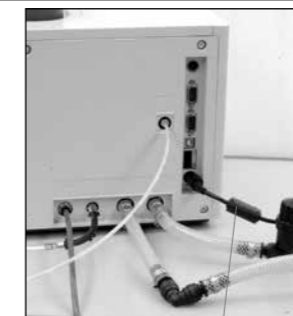

flat side of the connector

Connecting cable



The desktop power supply (scope of delivery) must not be placed flat on the laboratory table. It must be protected against moisture and water penetration and must not be wet.

2. Tape the supplied rubber feet to the power supply. Place the power supply on the rubber feet. Connect the connection cable to the DC power supply to your supply network (100-240V AC 50/60 Hz).



Connection of peripherals

Heating: Control output for the connection of the IKA heating.

Scale: RS232 interface for connection of a scale (Mettler, Ohaus, Sortorius, Kern)
Interface parameters: Baud rate: 1200
Data its: 7
Parity: odd
Stop its: 1
Handshake: none

PC/Printer: RS232 interface for connecting a PC to control the C 1 (CalWin® C 6040) or a printer to output the measurement data.
Interface parameters: Baud rate: 9600
Data its: 8
Parity: none
Stop its: 1
Handshake: none

USB-B: USB device interface for connection the calorimeters to the PC (CalWin® C 6040). The connection simulates a serial interface on the PC.
Installation:
After the C 1 was connected with the supplied data cable to the PC, the C 1 tells the Windows operating system, which device driver is required.

This driver can be downloaded from the IKA website.
Find your driver at the following website:
<http://www.ika.com/ika/lws/download/usb-driver.zip>.

Programming-interface: (only for service)

24V= 24 V Voltage input for the included power supply table.



Heating (ext)

Scale (balance)

PC / Printer (PC)

USB-B (USB)

Programming (Prog) interface

24 V =

Handling the unit

1. Opening the unit

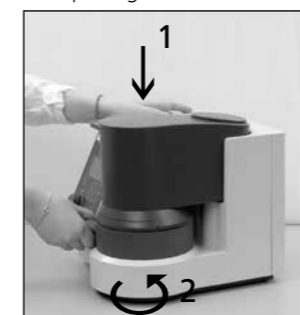

The closing of the unit in the reverse order

2. Removing the inner vessel

Inserting the inner vessel takes place in the reverse order

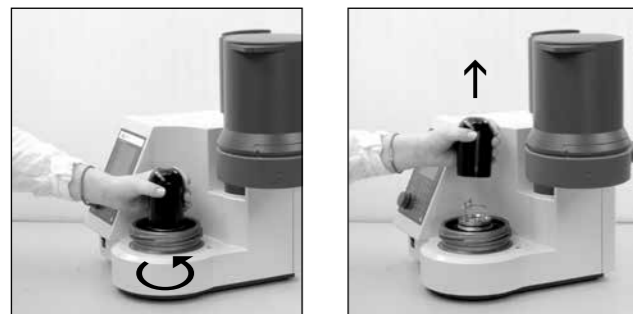

3. Removing the inner vessel base

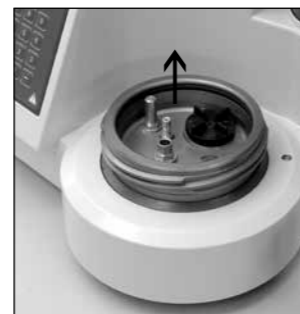

4. Switch on the device

Open the device and switch the device on and off with the front power switch.



Control unit with display

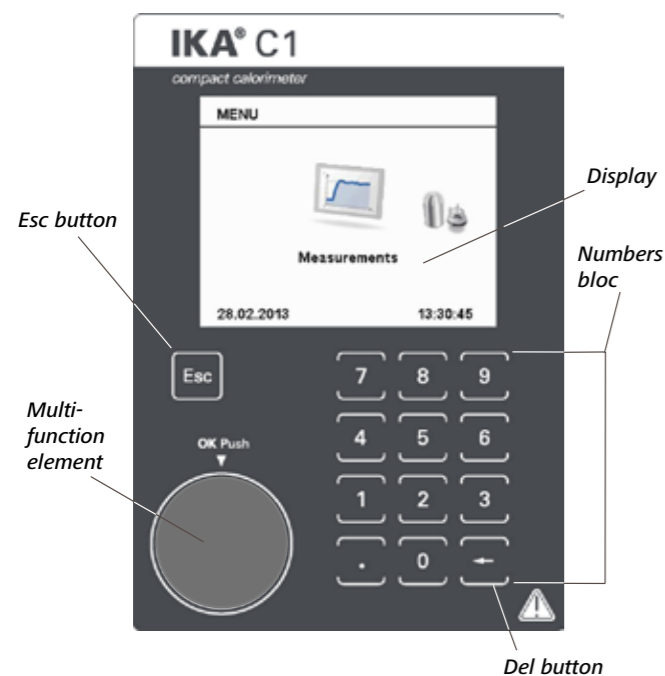

- Display:** View system information, test data, as well as menus and dialog boxes for the data input
- Numbers bloc:** Entering numbers and decimal points
- Del button:** Deleting an entered character string to the left of the cursor (eg the weight of a combustion sample)
- Multifunction element**
Made possible by turning the scroll and select menu items, as well as by pressing the Change and confirm input values
- Esc button:** The Esc-(Escape) function is active in the menu structure, the input window and input fields.
 - In the menu structure (if any) change to the parent menu
 - In the input window is changed to the higher level menu structure
 - When the ESC button is pressed in an editable field, the editing is finished and the original value is restored.

Dialog box

The dialog boxes are equipped with the following elements:

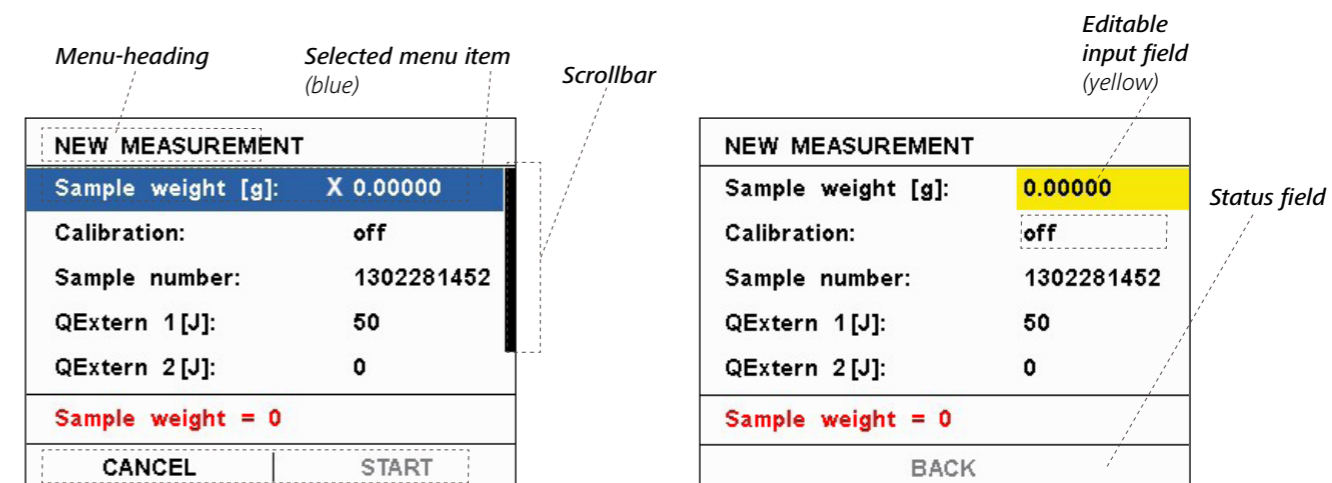

Menu options resp. user notification

Menu-heading:

The name of the currently displayed window

Selected menu item:

The blue background (cursor) marks the selected item. The position can be changed by turning the multifunction element.

Scrollbar:

If a menu window more entries can be displayed as the current is displayed a scrollbar. Turn the multi-function element, the other menu items are visible.

User notifications:

Some windows have a field in the user notes will be displayed.

Menu options:

They allow a "getting ahead" from the current window.
In the following example, the most frequently displayed menu options are listed and described:

- "Break off": Closing a window, the changes made will not be accepted by the system. Also possible using [ESC].

- „Back“: Closing a info window without information input values and return to the parent menu. Also possible using [ESC].
- „Accept“: Closing a window. Changes made are saved by the system.
- „Start“: Starting a measurement.
- „Details“: Detailed information during a running measurement.
- „Graph“: View graph during a running measurement.

Editable input field:

They can be enabled for value entry by pressing the multi-function element. The background color of the active field is indicated in yellow. By using the numeric keys or by turning the multi-function element, the input values can be changed.

Status field:

Display the device status, which is important for the user and operation.



On confirmation changes will not be applied

On confirmation changes will be applied

System start

Switching on the system (in the open state)



After switching on the calorimeter, first the initial screen with the IKA logo, the calorimeter-type and the software and firmware version.

INFO: Upon initial system start, the menu language must be selected.

See capture - "Selection of language"



A menu language has been selected, the splash screen will change to the following information window:

INFO: Exceed the number of ignitions devices, the maximum recommended number of ignition, a pressure test must be performed with the device. An additional information window is displayed.

See capture - "Pressure test"

INFO: If the oxygen pressure is too low, a corresponding user information is displayed.

See capture - "Oxygen pressure too low"

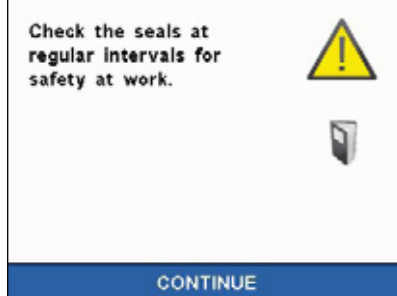

By an verification (pressing the multifunction element) another user information on the proper use of the system is shown.

Refer to the chapter "Care and Maintenance".

INFO: When the system is closed, a purge routine is started.

See capture - "System check"

INFO: Has been selected in the settings menu under accessories heating option, but this is not detected, user information is displayed.

See capture - "Heating detection - System start"

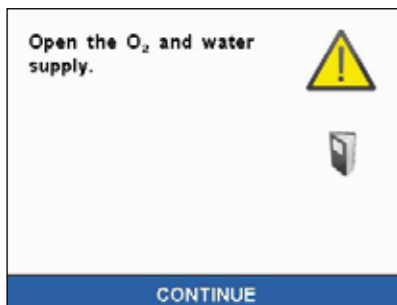

Selection of language



Pressure test

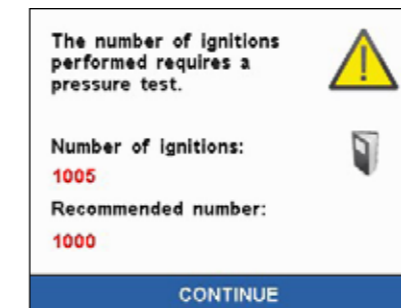

A pressure test must be performed after a decomposition vessel has reached or exceeded the recommended number of ignition cycles.

Once the pressure test has been performed a release code can be entered to enable the unit to be used for further measurements. The warning message will then disappear. The enable code can be in the following screen, by pressing the "Next button" to be entered.

INFO: Using the unit may be further worked.

Contact for performing the pressure test, the service department from IKA Works. Observe the safety instructions!

service@ika.de

Oxygen pressure



Information screen: oxygen pressure is too low.

NOTE:

The calorimeter C 1 required for functionality an oxygen pressure of at least 20 bar.

Reproducible measurements for a working pressure of 30 bar is required.

System check

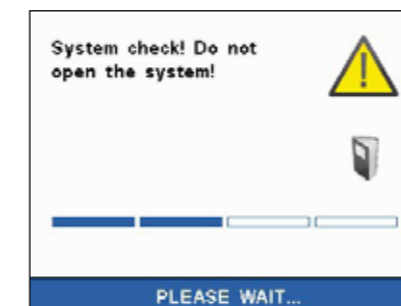

System start when the device is closed. The system is brought through the system check in a safe and completely deflated state. For this, the oxygen and water discharge is performed.

Here, the following information screen is displayed:

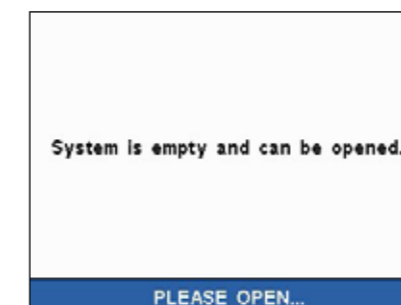

INFO: During the system check detected no oxygen or the oxygen pressure is too low, the following error message is displayed:

Heating detected

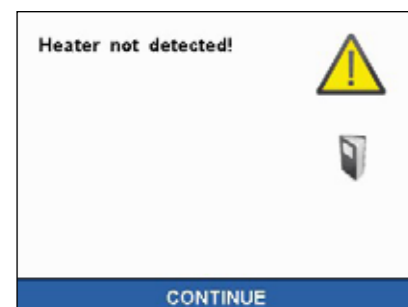

If the use of heating selected C 1.20 (accessories) in the Setting menu, but this is not recognized, the following user information is displayed.

NOTE:
Check that the heater is correctly connected and turned on.

Factory settings

As delivered, the C 1 calorimeter system is configured as follows:

Settings:

• Menu:	animated	• Heating:	off
• Color palette:	white	• Disposable crucible:	no
• Key tones:	on	• Printer:	off
• Date device:	01.01.2012	• Service Info:	no
• Time device:	00:00:00 Uhr	• Scale:	off
• Units:	J/g		

Basic settings:

• C-value IB1:	0	• QExternally 1:	50
• C-value IB2:	0	• QExternally 2:	0
• Reference calorific value:	26457	• Controlled time:	off
• Start temperature:	22 °C	• O ₂ rinsing:	off
• H ₂ O Combustible crucible:	19839	• Cooling:	on
		• Prolonged venting:	0

Calorimetric measurements

Determination of gross calorific value

Test condition

Combustion is carried out in a calorimeter under specific conditions.

The IKA C 1 is filled with a weighed fuel sample, the fuel sample is ignited and the temperature increase in the calorimeter system measured.

The specific calorific value of the sample is calculated as follows:

- Weight of fuel sample
- Heat capacity (C-value) of calorimeter system
- Calculated temperature increase of water in the calorimeter system

For complete combust on the inner vessel is filled with pure oxygen (quality 3.5). The pressure of the oxygen atmosphere in the inner vessel is max. 40 bar.

The exact determinat on of the gross calorific value of a substance requires that the combust on proceed under precisely defined conditons. The applicable standards are based on the following assumptons:

- Depending on the start temperature that is set, the temperature of the fuel before the combustion is 20 °C upto 30 °C.
- The water contained in the fuel before the combustion and the water that is formed when compounds comprising the fuel containing hydrogen undergo combustion is present in a liquid state.
- No oxidation of the atmospheric nitrogen has taken place.
- The gaseous products after combustion consist of oxygen, nitrogen, carbon dioxide, sulfur dioxide and the oxidation products of the sample.

- Solid substances may be formed (for example ash).

Often, however, the combustion products that form the basis of the standards are not the only products that are formed. In such cases, an analysis of the fuel sample and the products of combustion are necessary to provide data for a correction calculation. The standard gross calorific value is then determined from the measured gross calorific value and the analysis data.

The gross **calorific value Ho** is formed as the quotient of the amount of heat liberated upon total combustion of a solid or liquid fuel and the weight of the fuel sample. The compounds comprising the fuel that contain water must be present in liquid state after the combustion.

The **heat value Hu** is equal to the gross calorific value less the energy of condensation of the water that was contained in the fuel and was formed by the combustion. The heat value is the more important quantity for technical purposes, since in all important technical applications, the heat value is the only quantity that can be evaluated in terms of energy.

For information on the fundamental principles of calculation for gross calorific value and heat value, please refer to the applicable standards (for example: DIN 51 900; ASTM D 240;ASTM D 1989, ISO 1928).

Corrections

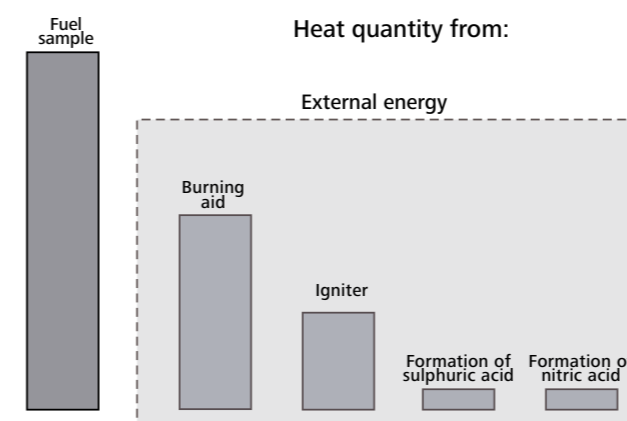

As determined by the system, during a combustion experiment, not only is **heat generated from the combustion** of the sample, but heat also occurs in the form of **extraneous energy**.

This may fluctuate considerably in proportion to the heat energy of the fuel sample.

The combustion heat of the cotton thread that ignites the sample and the electrical ignition energy would result in distorted values of the measurement. This effect is taken into consideration in the calculation with a correction value.

Substances with low flammability or substances that burn poorly undergo combustion in combination with **combustion aids**. The combustion aid is first weighed and then added to the crucible with the sample. From the weight of the combustion aid and its known specific gross calorific value, it is then possible to determine the quantity of heat that is introduced thereby. The result of the experiment must be corrected by this amount of heat. The C 14 disposable crucible is a combustible crucible that can be used instead of a traditional crucible. The disposable crucible undergoes total combustion with no residue. If a disposable crucible is used, there is then no need for a cotton thread. The crucible is in direct contact and is ignited by the fixed ignition

Notes on the sample

The calorimeter system IKA C 1 is a precision measuring instrument for the routine determination of calorific values of solid and liquid substances. Exact measurements can however be achieved only if the individual steps of the trial are performed with care. The procedure as described in the "For your safety" section 1 and in the following sections must therefore be adhered to exactly.

 **DANGER** If you are burning unknown samples, leave the room or keep well away from the calorimeter!

A few points should be noted in respect of the substances to be combusted:

- Normally, solid substances can be burned directly in powder form. Rapidly burning substances (for example benzoic acid) must not undergo combustion in loose form. Benzoic acid must only be burned in the form of pellets! Combustible dust and powder must be compressed into pellets before combustion. Oven-dry dust and powder such as wood chips, hay, straw etc. burn in an explosive manner! They must be moistened first! Readily combustible liquids with a low vapor pressure must not be come in direct contact with the cotton thread (e.g. tetramethyl dihydrogen disiloxan).

wire of the inner vessel.

Inner vessel in which the combustible crucible is to be used, must be fitted with an additional overlay (see accessories). The sample is weighed directly into the disposable crucible. In most cases, no additional combustion aid is necessary because the disposable crucible itself acts as the combustion aid.

Acid correction

Almost all substances to be analyzed contain sulfur and nitrogen. Under the conditions that pre-vail during calorimetric measurements, sulfur and nitrogen undergo combustion and form SO₂, SO₃ and NO_x. Sulfuric and nitric acid arise in combination with water resulting from combustion and humidity. Heat of solution is also generated. To obtain the standard gross calorific value, the effect of the heat of solution on the gross calorific value is corrected.

To obtain a defined final status and to record all acids quantitatively, approx 5ml distilled water or another suitable absorption solution is placed in the inner vessel. With this absorption fluid and the combustion water, the combustion gases form acids.

After the combustion, the decomposition vessel is thoroughly washed with distilled water so as to collect the condensate that has settled on the inner wall of the vessel as well. The solution obtained in this manner can now be examined with a suitable peripheral detection device for aqueous decomposition into the respective acid content.

For more information on this subject, please contact IKA, or your nearest authorized dealer.

When calculating the energy value in C 1 external energies are taken into account from kiln furniture, however, there is no correction of acid. The calorific value is not calculated.

To do this, use the calorimeter software IKA CalWin®.

Rapidly burning substances tend to squirt. Such substances must be pressed into tablets before combustion. Suitable for this is e.g. the IKA pelleting press C 21.

- Most liquid substances can be weighed directly into the crucible. Liquid substances exhibiting turbidity or containing water that will settle out must be dried or homogenized before they are weighed in. The water content of these samples must be determined.
- Highly volatile substances are placed in combustion capsules (gelatin capsules or acetobutyrate capsules, see "Accessories") and undergo combustion together with the capsules.
- For substances with low flammability or low calorific substances use combustion aids (see "Accessories"). Before the capsules or the combustion bag is filled with the substance to be determined, it must be weighed in order to determine the additional extraneous energy introduced into the system from the weight and the gross calorific value. This is taken into consideration with QExtern2. The amount of combustion aid should be as little as possible.

The external energy must be determined externally.

- Under the conditions that prevail during calorimetric measurements, sulfur and nitrogen undergo combustion and form SO₂, SO₃ and NO_x. Sulfuric and nitric acid arise in combination with the water resulting from combustion. Heat of solution is also generated. This heat of solution is taken into consideration in calculating the gross calorific value. In order to quantitatively record and determine all acids that have been formed, about 5 ml of distilled water or another suitable substance can be added to the decomposition vessel before the experiment.

The calibration of the system must have been performed in accordance with the instructions!

Remove after measuring the complete inner vessel. Turn the inner container upside down, loosen gently the internal container bottom. Rinse thoroughly with distilled water, the inner area of the inner container. The rinsing water and the solution formed from the water that was added are combined and the acid content of the combined solution is examined. If the sulfur content of the combustion aid and the nitric acid correction are known, the water does not need to be analyzed.



Complete combustion

To correctly determine the gross calorific value, it is of fundamental importance that the sample undergoes complete combustion. After each experiment, the crucible and all solid residues must be examined for any signs that combustion was not complete.

In case of using substances tending to squirt it is not possible to ensure complete combustion.

Substances with low flammability (substances with a high content of mineral matter and low-calorific substances) will often

Calibration

To ensure precise, reproducible results of the measurement, the calorimeter system is calibrated after it is initially placed in service, after service jobs, after parts are replaced and at specific time intervals. During calibration, the heat capacity of the calorimeter system is redetermined.

Regular calibration is absolutely essential to obtain accurate measurements!

For this purpose, a specific quantity of a reference substance undergoes combustion in the IKA C 1 under the conditions of the experiment. Since the gross calorific value of the reference substance is known, it is possible after combustion has occurred

Notes on calibration

Ensure that calibration is carried out under the same conditions as the subsequent tests. If substances are used in the decomposition vessel in combustion tests (e.g. distilled water or solutions), you must use exactly the same amount of this substance for calibration.

These correction values can not be entered in C 1. For this, use the IKA calorimeter software CalWin®.

To increase the service life of parts to wear and tear (O rings, seals etc.) we recommend to work with water added to the experiment as a matter of general principle.

Halogen rich substances can cause corrosion on the inner container.

These substances must not be burned in C 1 with the standard inner vessel.

In halogen-rich substances of special halogen-resistant inner vessel C 1.12 must be used.

undergo complete combustion only with the aid of combustion capsules or combustion bags (C 10/ C 12 see "Accessories"). It is also possible to use liquid combustion aids such as paraffin oil.

The combustion aids as well (for example the cotton thread) must undergo complete combustion. If unburned residues are left over, the experiment must be repeated.

to calculate the heat capacity based on the increase in temperature of the calorimeter system. The reference substance for calorimetry on an international level is benzoic acid of the National Bureau of Standards (NBS Standard Sample 39 J) with a guaranteed gross calorific value.

For more detailed information on calibration please see the relevant standards.

If the IKA C 1 is operated with several different decomposition vessels, you will need to determine the heat capacity of the system for each decomposition vessel. The parts of each decomposition vessel must then not be swapped with parts from other vessels.

For determination of calorific values the increase in temperature must be about as great as for the calibration (± 30%). 1g benzoic acid \approx 6K. The optimum sample quantity must be determined by several trials where necessary.

Overview Main menu

The user has two display modes available.

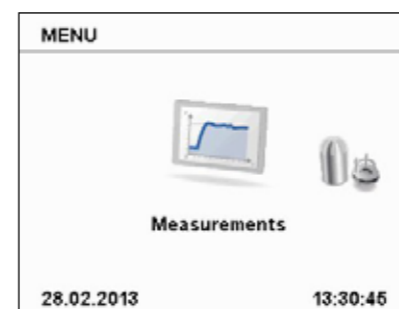

Animated view

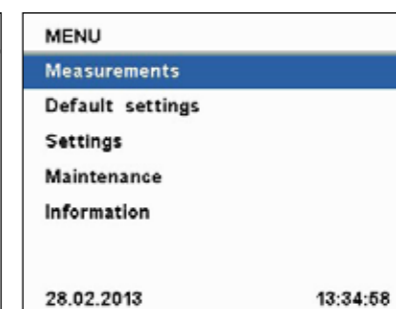

List view

Measurements



The following submenus are available:

- New measurement
- Last result
- System test
- Measurement archive
- Calibration archive
- Memory overview

Default settings



The following submenus are available:

- C-value IB1
- ID IB1
- C-value IB2
- ID IB2
- Ref. cal. value
- Ho Comb. cruc.
- Start temperature
- QExtern 1
- QExtern 2
- O₂ rinse
- Cool Down
- Extend. O₂ Emptying

Settings

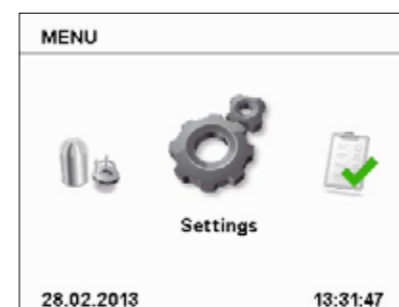

The following submenus are available:

- Date / Time
- Units
- Display / Keypad
- Language
- Accessories
- Cooler test

Maintenance

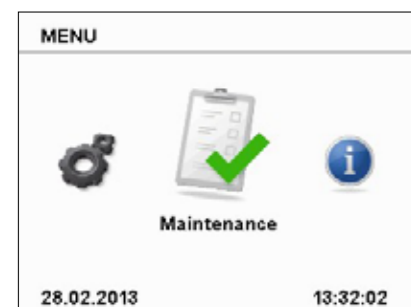

The following submenus are available:

- Change seal
- Test stirrer
- O₂ System blow
- Servo up
- Servo down

INFO: When performing maintenance programs, the system must be open !

Information

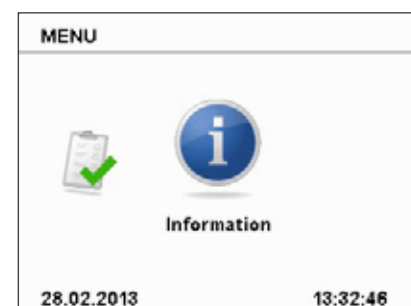

The following informations are available:

- Software
- Firmware
- Serial number
- Service
- Pressure test
- Ignitions
- Next test
- Support

Preparing and performing measurements

The term "measurements" below refers to both the measurements to calibrate the calorimeter system (calibration measurements) and the actual measurements for determining the calorific value. The difference lies mainly in the evaluation, whilst preparation and performance make virtually no difference.

Performing the measurement

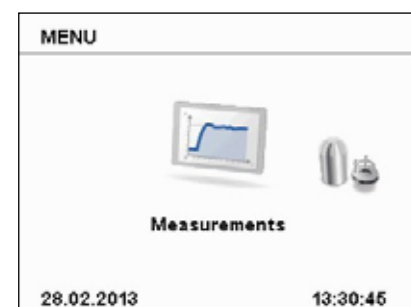

Select and confirm "Measurements" in the main menu with the multi-function element.

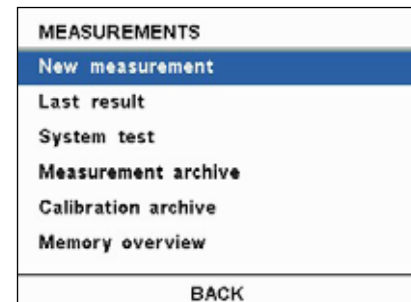

In the submenu select and confirm the option "New measurement".

NEW MEASUREMENT	
Sample weight [g]:	X 0.00000
Calibration:	off
Sample number:	1302281452
QExtern 1 [J]:	50
QExtern 2 [J]:	0
Sample weight = 0	
CANCEL	OK

Input window NEW MEASUREMENT

Select and confirm the menu item "Sample weight". Enter the sample weight with numeric keypad and confirm.

INFO: A distinction is made between the use and non disposable cup. Use of disposable crucible can be selected in *Settings* → *Accessories*.

INFO: For automatic input of the weight may be a connected scale can be used

INFO: The inputted weight values are checked for permissibility.

INFO: The existing store will be reviewed after the entry of a new measurement / calibration and a user note displayed if it is not possible to save the measurement / calibration.

NOTE:

Ensure that a maximum energy input of from 40,000 joules is not exceeded.

NOTE:

For more, detailed descriptions of the individual menu items are treated in the chapter "Calorimetric Measurements".

INFO: If a scale is used in activation of the input field, the weight is automatically queried. It can be pressed on the scale alternatively, the transmit button.

Fill in the sample weight.

NEW MEASUREMENT	
Sample weight [g]:	0.00000
Calibration:	off
Sample number:	1302281452
QExtern 1 [J]:	50
QExtern 2 [J]:	0
Sample weight = 0	
BACK	

NEW MEASUREMENT	
Sample weight [g]:	2.50000
Calibration:	off
Sample number:	1302281456
QExtern 1 [J]:	50
QExtern 2 [J]:	0
Sample weight within limit	
CANCEL	OK

Calibration off.

NEW MEASUREMENT	
Calibration:	off
Sample number:	1302281456
QExtern 1 [J]:	50
QExtern 2 [J]:	0
IV no.:	1
CANCEL	OK

When you are ready with your input, press "OK" button.



Don't close the C 1 before you have pressed "OK" button!

Placing the sample

During the prerequisite checking, the cotton thread can be attached to the ignition wire, hung the crucible in the provided holder and the sample are contacted with the ignition wire.

When using a disposable crucible of contact between the ignition wire and the combustible crucible must be present. The fixing of the cotton thread is not necessary.

Preparing a measurement

The inner container base remains in the control of sample preparation in the calorimeter. But you can also use it by pulling it out individually, or for consequential - Analysis - determinations, refer to the closed inner container.

The following preparations must be made to prepare the system for a measurement:

1. Attach with a loop a cotton thread centered on the ignition wire (at the open calorimeter).
2. Weigh the substance with an accuracy of 0.1 mg directly into the crucible. Where appropriate distilled water or a solution must be presented in the inner vessel.

The input of the maximum possible sample weight is limited to a maximum of 5 g.

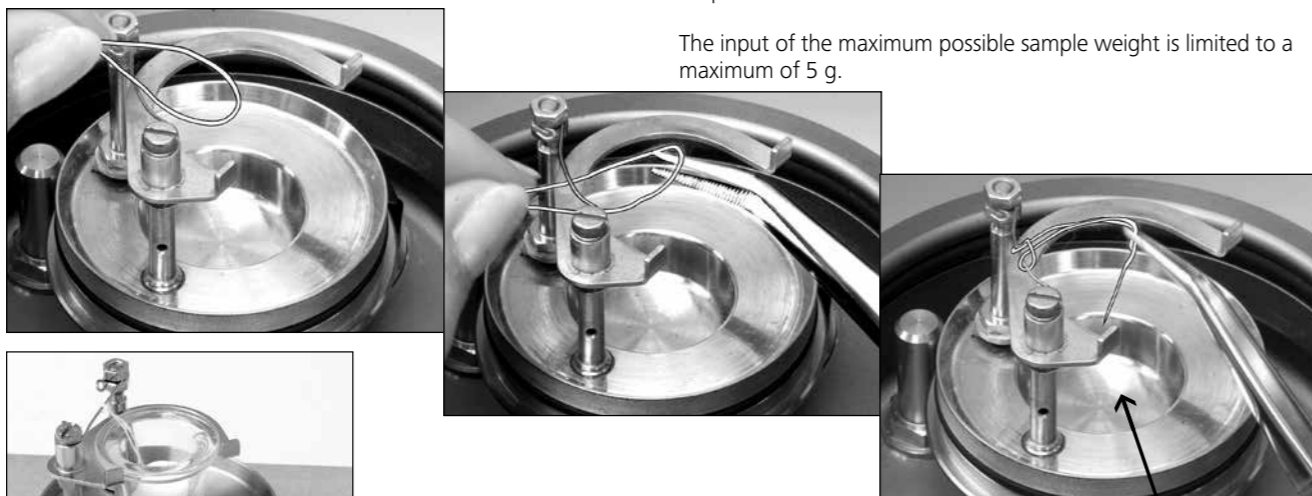

Impression for distilled water or a solution as a template

C 6 Quartz crucible

To increase the service life of wearing parts (O-rings, seals, etc.) it is advisable to always work with a water template.

Generally, the test sample must be selected so that the temperature elevation during the measurement is below 10 K and the temperature increase of the calibration comes close (max. energy input: 40,000 J). Such exposure may damage the calorimeter.

When exceeding the maximum energy input is recommended to return the calorimeter.

To determine the potential energy initially very small sample weights (approx. 0.2g) must be chosen when working with unknown substances. If you burn unknown samples, leave the room or keep your distance from the calorimeter.

If distilled water or solutions presented in the decomposition vessel during the combustion experiment, the calibration with the same template must have been performed before.

Close the calorimeter

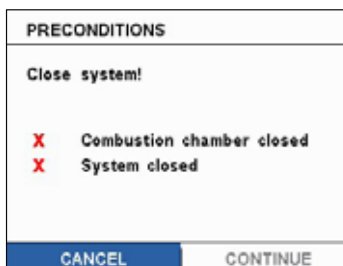

After the sample is loaded and the contact with the ignition wire is present and the inner vessel was placed, the calorimeter is sealed.

The following screen informs the user whether the system is closed properly and securely.

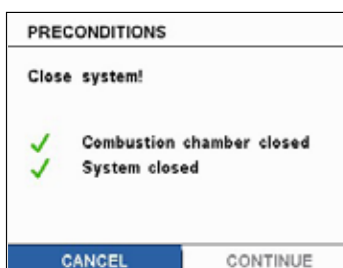

Are combustion vessel and the complete system properly closed, the measurement starts automatically.

Note:

Can the inner container and / or closure ring with handle heavy wire, please follow the instructions for oiling the seals!

Prerequisite checking for a measurement

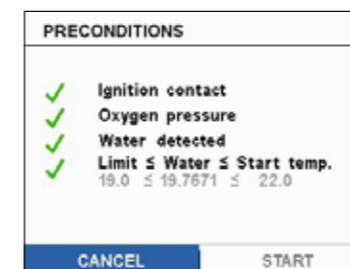

Without C 1.20 heating:

When checking the preconditions for a measurement using a distinction is made with and without C 1.20 heating between. The following points should be checked:

- Existing Ignition
- Sufficient oxygen present
- Open water connection
- Tempered water or using a heating their functionality

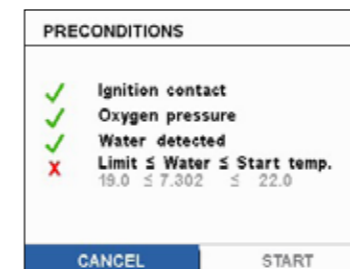

With C 1.20 heating:

- **Ignition:** Checking whether ignition contact available
- **Oxygen pressure:** Check whether the system has sufficiently high oxygen pressure has to make a measurement
- **Water detected:** Check whether the system has detected water
- **Limit ≤ Water ≤ Start temp.:** Check whether there is the current water temperature within the permissible temperature range
- **Heater test:** Check the heating functionality

Measurement procedure

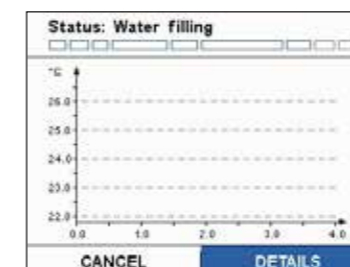

During a measurement, different phases are passed through. These phases are described below

- **Phase 1:** Filling the calorimeter with water

NOTE:

After switching on the calorimeter C 1 or after a break of 2 hours during the filling of the calorimeter C 1 is still carried out an intermediate emptying (H₂O - purge). Once the water sensor detects water, the stirrer is switched on. After a short waiting period begins phase 2.

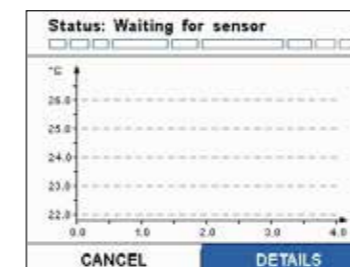

- **Phase 2:** Filling the calorimeter with oxygen (Note: If the option-O₂ flushing under the main menu → Basic Settings is selected, the inner vessel is two times with Oxygen rinsed)

NOTE:

Alternatively, to display the graph may also have a detailed view of be selected with the following information:



- **Current temperature:** Mean value of the actual temperatures
- **Ignition temperature:** the currently measured temperature
- **Measurement time:** Display: duration of the measurement

Status: Waiting for sensor	
Current temp. [°C]:	27.705
Ignition temperature [°C]:	0.0
Measuring time [m:ss]:	0:00
Filling time [m:ss]:	0:28

- **Fill time:** Filling the inner vessel with water. The fill time is user specific and must be kept constant on each measurement. Check the filter where long fill times are used.

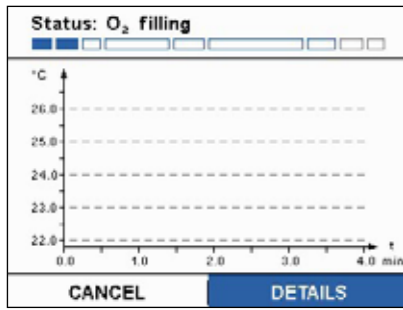

- Phase 3:
Filling with oxygen

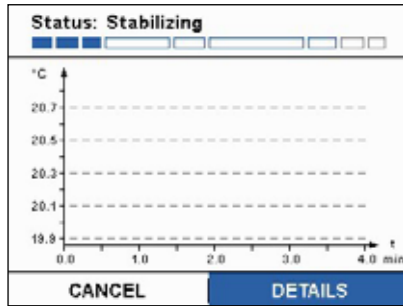

- Phase 4:
Stabilizing the temperature and preliminary

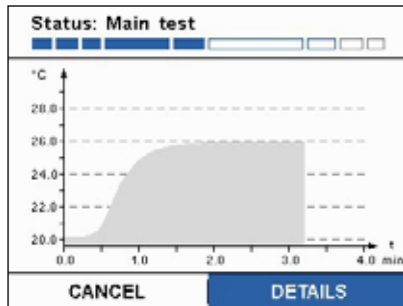

- Phase 5:
The system ignites and thereby starts the main test

INFO: An ongoing measurement can be stopped by selecting "Cancel" at any stage

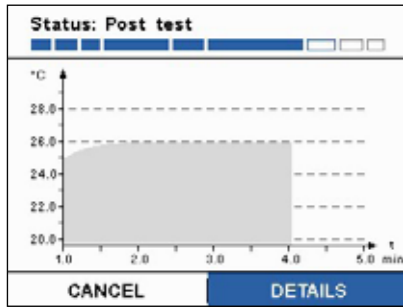

- Phase 6:
Post test

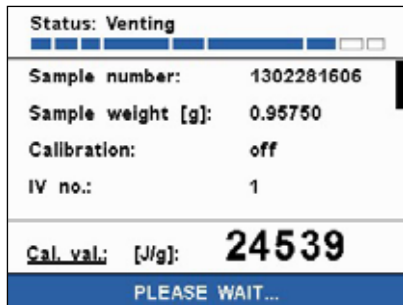

- Phase 7:
Venting, result is displayed

- Phase 8:
Cooling (if option under the main menu → Basic Settings → cooling is enabled) and water emptying

NOTE: With the "cooling" option, the energy is absorbed (by the combustion in the calorimeter entered). Deactivation, the measuring time and the accuracy of the calorimeter affecting (depending on the sample throughput).

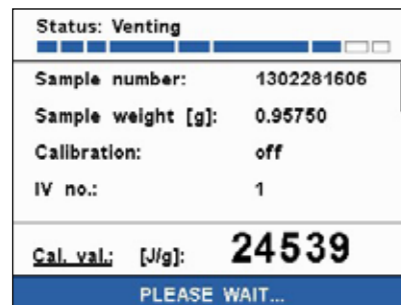
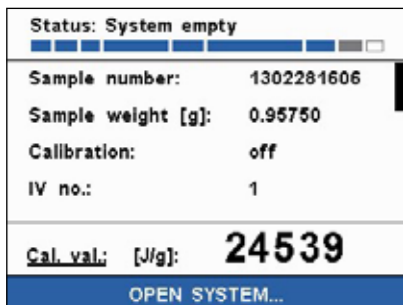

- Phase 9:
The system is completely emptied, and can be opened.

The inner vessel can be taken down. Through a visual check is necessary to ensure that the sample in the crucible was combusted completely.

Result Display

Status: Waiting Sample number: 1302281456 Sample weight [g]: 0.95750 Calibration: off IV no.: 1 Cal. val.: [J/g]: 24495 OK	Status: Waiting IV no.: 1 IV C-value [J/K]: 4000 QExtern 1 [J]: 50 QExtern 2 [J]: 0 Cal. val.: [J/g]: 24495 OK	Status: Waiting QExtern 2 [J]: 0 QIgnition [J]: 0.0 Delta T: [K]: 5.8761 Ref. cal. val.: [J/g]: 26457 Cal. val.: [J/g]: 24495 OK	Status: Waiting QIgnition [J]: 0.0 Delta T: [K]: 5.8761 Ref. cal. val.: [J/g]: 26457 Ignition temp. [°C]: 20.10 Cal. val.: [J/g]: 24495 OK
--	--	--	--

Cleaning the inner vessel

After each combustion are all parts of the inner vessel that come in contact with the combustion products to clean condensate. It is sufficient to parts with an absorbent, lint-free cloth to wipe off. Combustion residues in the inner vessel, for example, soot or ash are eliminated in the same way. Can not be cleaned in the manner described (eg due to burn-in or pitting corrosion) of

the inner vessel, it shall be subjected to no cases of mechanical cleaning.

Please contact in such cases, contact your local service center or send the inner vessel for inspection and cleaning to our factory.

Follow-up measurement

MEASUREMENTS
New measurement
Last result
System test
Measurement archive
Calibration archive
Memory overview
BACK

By pressing the multi-function element, the result display returns to the measurement sub-menu and the next attempt can be started.

NOTE:

Because the calorimeter C 1 (all internal parts) still not in a first measurement at operating temperature, the result of the first measurement can differ significantly from the subsequent measurements of a test series. We therefore recommend not to evaluate the outcome and possibly to delete. Alternatively, a system test can be performed, see chap. "System Test".

Display the storage overview

CHECK ARCHIVE MEMORY!																			
<table border="1"> <thead> <tr><th>Calib.</th><th>Curr.</th><th>Max</th></tr> </thead> <tbody> <tr><td>IV1 22°C</td><td>14</td><td>15</td></tr> <tr><td>IV1 30°C</td><td>0</td><td>15</td></tr> <tr><td>IV2 22°C</td><td>0</td><td>15</td></tr> <tr><td>IV2 30°C</td><td>0</td><td>15</td></tr> <tr><td>Meas.</td><td>30</td><td>100</td></tr> </tbody> </table>	Calib.	Curr.	Max	IV1 22°C	14	15	IV1 30°C	0	15	IV2 22°C	0	15	IV2 30°C	0	15	Meas.	30	100	
Calib.	Curr.	Max																	
IV1 22°C	14	15																	
IV1 30°C	0	15																	
IV2 22°C	0	15																	
IV2 30°C	0	15																	
Meas.	30	100																	
OK																			

If after pressing the "New Measurement" button, the memory overview is displayed, the capacity of the storage spaces for measurements / calibrations are almost depleted. If the maximum number is reached, no new measurements / calibrations more can be saved for this mode. By pressing the OK key to access the screen "New Measurement". Delete measurements / calibrations are no longer needed.

Use of a disposable crucible

NEW MEASUREMENT
Sample weight [g]: X 0.00000
Calibration: off
Sample number: 1302281452
QExtern 1 [J]: 50
QExtern 2 [J]: 0
Sample weight = 0
CANCEL START

The disposable crucible can optionally be used instead of metal or quartz crucible and burned during the measurement complete (see chap. "Accessories").

INFO: 50 Joule omitted. With the combustible crucible not a cotton thread is used.

Using a scale

NEW MEASUREMENT	
Sample weight [g]:	0.00000
Calibration:	off
Sample number:	1302281452
QExtern 1[J]:	50
QExtern 2[J]:	0
Sample weight = 0	
BACK	

About *Settings* → *accessories* can be selected using a scale.

If this option is selected, the displayed on the scale weight is automatically transmitted to the selected weight input field. Depending on type of balance this function may need to be activated on the scale or the Transfer button must be pressed.

This applies both to the initial sample weight of the sample and the weight of the disposable crucible.

NEW MEASUREMENT	
Sample weight [g]:	X 0.00000
Calibration:	off
Sample number:	1302281456
Comb. crucible [g]:	X 0.00000
QExtern 2[J]:	0
Sample weight = 0 Comb. cruc. = 0	
CANCEL	START

NEW MEASUREMENT	
Calibration:	off
Sample number:	1302281456
Comb. crucible [g]:	X 1.00000
QExtern 2[J]:	0
IV no.:	1
Combustible crucible ≥ MAX	
CANCEL	START

NEW MEASUREMENT	
Calibration:	off
Sample number:	1302281456
Comb. crucible [g]:	0.14899
QExtern 2[J]:	0
IV no.:	1
CANCEL	START

NEW MEASUREMENT	
Calibration:	off
Sample number:	1302281456
Comb. crucible [g]:	0.14899
QExtern 2[J]:	0
IV no.:	1
CANCEL	START

Permissible weight entries

NEW MEASUREMENT	
Sample weight [g]:	2.50000
Calibration:	on
Sample number:	1302281456
Comb. crucible [g]:	X 1.00000
QExtern 2[J]:	0
W. samp. limit Comb. cruc. ≥ MAX	
CANCEL	START

In a non-permissible weight is the OK button inactive (grayed out) and can not be selected..

- Sample weight:**
 There are weights of 0.00001 g to 4.99999 g permitted!
 From 2.5 g in addition the message appears that the sample weight in the limit range is (initial mass in the limit).
- Combustible crucible:**
 There are weights of 0.00001 g to 0.99999 g permitted!
 Weights greater than 0.99999 g are not possible.

Example: sample weight in the limit and initial weight of the combustible crucible too high

NEW MEASUREMENT	
Sample weight [g]:	X 0.00000
Calibration:	off
Sample number:	1302281452
QExtern 1[J]:	50
QExtern 2[J]:	0
Sample weight = 0	
CANCEL	START

Confirm the selection with OK button.

Cancel a measurement

Do you really want to cancel the current measurement?	
YES	NO

An ongoing measurement can be cancelled at any time.

After ignition, the system waits for 1 minute with the emptying, as otherwise there is a risk that the sample is not completely burned.

After confirm the cancellation, the system automatically emptied and bring it to a safe state. The calorimeter can be opened and you can return to the main menu.

Measurements

New measurements

MEASUREMENTS
New measurement
Last result
System test
Measurement archive
Calibration archive
Memory overview
BACK

- New measurement:**
 Preparing and starting a measurement
- Last result:**
 Displaying the result of the last measurement
- System test:**
 The functionality of the calorimeter is checked
- Measurement archive:**
 The system can store up to 100 measurements
- Calibration archive:**
 The system can be used for both modes of operation (22 °C, and 30 °C) for each inner container (1 and 2) each storing 15 calibrations.
- Memory Summary:**
 Display the memory summary

Last result

LAST RESULT	
Sample number:	1302281456
Sample weight [g]:	0.9575
Calibration:	off
IV no.:	1
IV C-value [J/K]:	4000
Cal. val.: [J/g]:	24495
BACK	

This screen shows the results of the measurement carried out previously successfully.

LAST RESULT	
IV C-value [J/K]:	4000
QExtern 1[J]:	50
QExtern 2[J]:	0
QIgnition [J]:	0
Temp. increase:	5.8761
Cal. val.: [J/g]:	24495
BACK	

LAST RESULT	
QExtern 2[J]:	0
QIgnition [J]:	0
Temp. increase:	5.8761
Ref. cal. val.:	26457
Ignition temp. [°C]:	20.10
Cal. val.: [J/g]:	24495
BACK	

System test

MEASUREMENTS
New measurement
Last result
System test
Measurement archive
Calibration archive
Memory overview
BACK

Functional testing of the system

Use for the system test one or two benzoic acid tablets. Alternatively, however, for example, an appropriate amount of sugar or an alternative fuel to be used.

The system test is used to test the functionality of the overall system. For this purpose all switching operations are carried out, which take place in a normal measurement. If the system test performed without error, the functionality is guaranteed.

The system test can be used to create a quick "warm up" the system. It is faster than a normal measurement, since there is no analysis and improves the accuracy of the first measurement so that they need not be discarded

PRECONDITIONS	PRECONDITIONS	PRECONDITIONS	PRECONDITIONS
<p>Close system!</p> <p>X Combustion chamber closed</p> <p>X System closed</p> <p>CANCEL CONTINUE</p>	<p>Close system!</p> <p>✓ Combustion chamber closed</p> <p>X System closed</p> <p>CANCEL CONTINUE</p>	<p>✓ Ignition contact</p> <p>✓ Oxygen pressure</p> <p>X Water detected</p> <p>X Limit ≤ Water ≤ Start temp. 19.0 ≤ 19.7713 ≤ 22.0</p> <p>CANCEL START</p>	<p>✓ Ignition contact</p> <p>✓ Oxygen pressure</p> <p>✓ Water detected</p> <p>X Limit ≤ Water ≤ Start temp. 19.0 ≤ 7.302 ≤ 22.0</p> <p>CANCEL START</p>
<p>Status: Post test</p> <p>CANCEL DETAILS</p>	<p>INFORMATION</p> <p>The system test was successful.</p> <p>Status: Venting</p> <p>PLEASE WAIT...</p>	<p>INFORMATION</p> <p>The system test was successful.</p> <p>Status: System empty</p> <p>OPEN SYSTEM...</p>	

Measurement archive

MEASUREMENT ARCHIVE		
1	1303041648	26503
2	1303041636	26425
3	1303041614	26413
4	1303041556	26504
5	1303041545	26415
6	1303041532	26502
BACK	EDIT	

In measurements Archive up to 100 measurements can be stored. A measurement taken is automatically added to the archive.

Displays the line number, the name of the measurement as well as the result.

Further details are displayed by clicking on a measurement.

MEASUREMENT ARCHIVE		
25	1303040936	26490
26	1303040914	26470
27	1303040856	26475
28	1303040845	26505
29	1303040832	26461
30	1303040815	26449
BACK	EDIT	

MEASUREMENT ARCHIVE		MEASUREMENT ARCHIVE	
Sample number:	1303040815	IV C-value [J/K]:	4520
Sample weight [g]:	1.0975	QExtern 1 [J]:	50
Calibration:	off	QExtern 2 [J]:	0
IV no.:	1	QIgnition [J]:	75
IV C-value [J/K]:	4520	Temp. increase:	3.8457
Cal. val. [J/g]:	26449	Cal. val. [J/g]:	26449
BACK	BACK		

Measurement archive: Edit

MEASUREMENT ARCHIVE		
25	1303040936	26490
26	1303040914	26470
27	1303040856	26475
28	1303040845	26505
29	1303040832	26461
30	1303040815	26449
BACK	EDIT	

By clicking on the "EDIT" button in the list view another screen for selecting the edit mode.

Print:

- Measurements can be selected and printed

Delete:

- Measurements can be selected and deleted

Delete all:

- All measurements are deleted

By selecting one of these menu items to the list view is displayed again. As a heading of the screen active editing is displayed. The "EDIT" button is replaced with an "OK" button.

EDIT
Print
Delete
Delete all
BACK

Measurement archive: Print

PRINT		
1	1303041648	26503
2	1303041636	26425
3	1303041614	26413
4	1303041556	26504
5	1303041545	26415
6	1303041532	26502
BACK	OK	

Click on the individual measurements they are selected and marked with a green tick. By clicking again the selection is reversed

PRINT			USER INFO	
1	1303041648	26503	✓	<p>Print selected measurement(s) now?</p> <p>CANCEL OK</p>
2	1303041636	26425	✓	
3	1303041614	26413	✓	
4	1303041556	26504	✓	
5	1303041545	26415	✓	
6	1303041532	26502	✓	
BACK	OK		CANCEL OK	

By confirming the selected measurements with "OK" followed by the display of the user note. By confirming with "OK", the selected measurements are printed.

Measurement archive: Delete

DELETE		
1	1303041648	26503
2	1303041636	26425
3	1303041614	26413
4	1303041556	26504
5	1303041545	26415
6	1303041532	26502
BACK	OK	

By clicking the "OK" button, the following dialog appears:

By confirming with "OK", the selected measurements will be deleted.

DELETE			USER INFO	
1	1303041648	26503	✓	<p>Delete selected measurement(s) now?</p> <p>CANCEL OK</p>
2	1303041636	26425	✓	
3	1303041614	26413	✓	
4	1303041556	26504	✓	
5	1303041545	26415	✓	
6	1303041532	26502	✓	
BACK	OK		CANCEL OK	

Measurement archive: Delete all

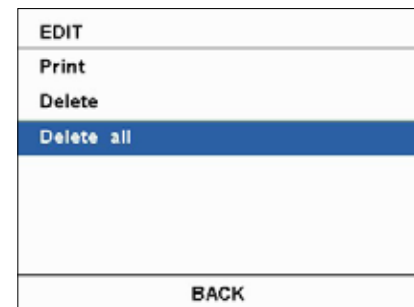

By clicking the "OK" button, the following dialog appears:

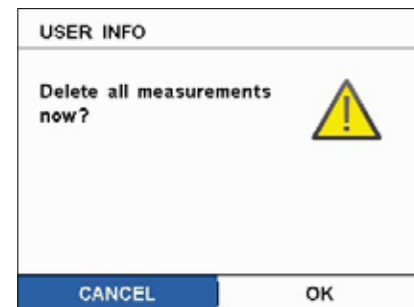

By confirming with "OK", all measurements will be deleted.

Calibration archive

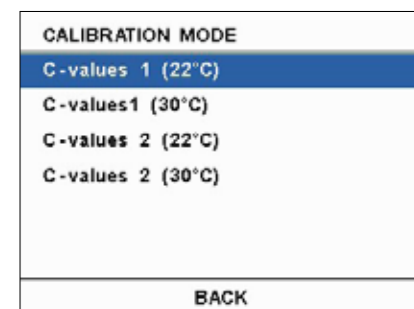

After selecting the appropriate archive is displayed.

INFO: In each calibration archive up to 15 calibrations can be stored. A calibration performed is automatically added to the appropriate archive

Displays the line number, the name of the calibration and the result (C value). Below the list of the current C-value of the system is shown (in red). By confirming the multifunctional element details concerning the measurement are displayed. For the C-value calculation, select "Edit".

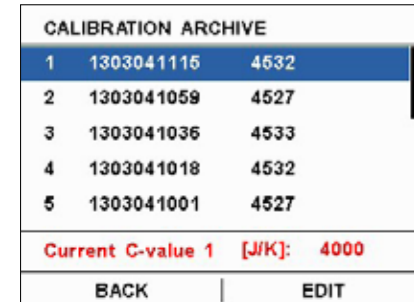

INFO: The C-value can also manually at *Main Menu > Basic settings* entered alternative.

Calibration archive: Edit

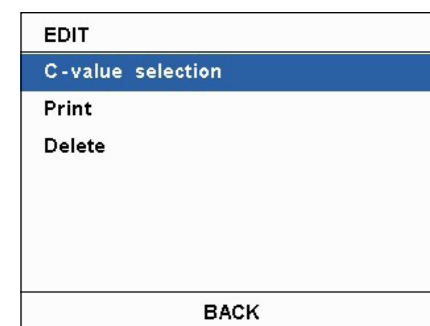

By clicking the "EDIT" button in the list view, another screen appears to select the edit mode.

Selection C values:

- Calibrations can contribute to the redefinition of the C-value be selected

Print:

- Calibrations can be selected and printed

Delete:

- Calibrations can be selected and deleted

By selecting one of these menu items to the list view is displayed again. When heading of the screen active editing is displayed. The "EDIT" button is replaced with an "OK" button.

Calibration archive: C-Value selection

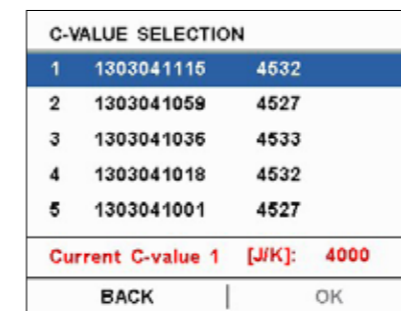

Click on the individual calibrations they are selected and marked with a green tick. By clicking again the selection is canceled and the new C-value (mean value) is displayed below the list view directly.

By clicking the "OK" button, the following user message appears:

By clicking the "OK" button, the new value is accepted.

INFO: For RSD calculation of at least two C-values must be selected. Otherwise, the result is Infinite and it is "Inf" is displayed as RSD.

Formula for calculating: X is a set of data (x1, ..., xn) and N the number

Relative Standard Deviation (RSD)
= (standard deviation / mean value) x 100

Mean value: $X = X_{Mean} = (\sum_{n=1}^N x_n) / N$

Standard deviation:
 $\sigma = \sqrt{\sum_{n=1}^N (X_n - X_{Mean})^2 / (N - 1)}$

INFO: The new value is also displayed under *Main menu* → *Basic settings*.

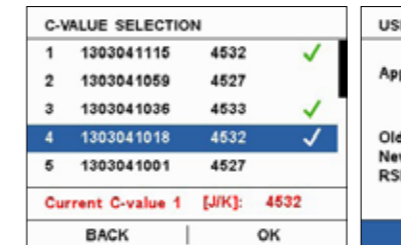

Calibration archive: Print

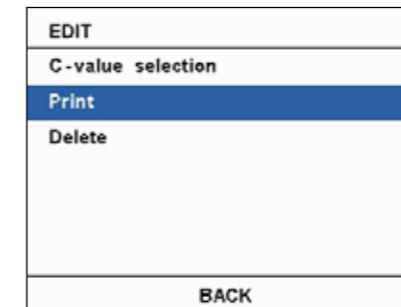

Click on the individual measurements they are selected and marked with a green tick. By clicking again the selection is reversed.

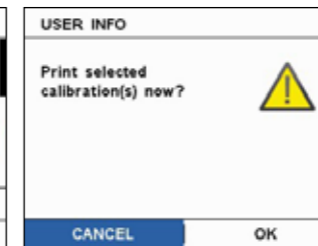
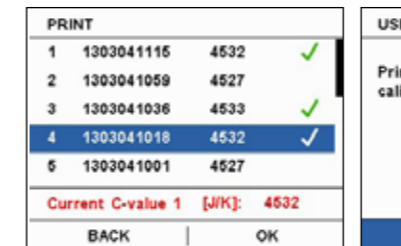

By clicking on the OK button, the following user dialog appears:

By confirming with "OK", the selected calibrations are printed.

Calibration archive: Delete

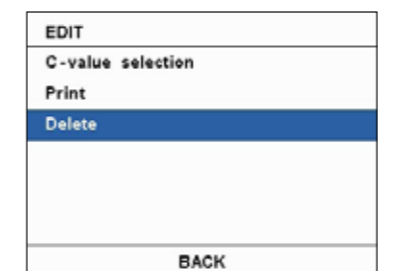

Click on the individual measurements they are selected and marked with a green tick. By clicking again the selection is reversed.

INFO: Calibrations that are used to the current C-value calculation, can not be deleted. She are grayed out and can not be selected..

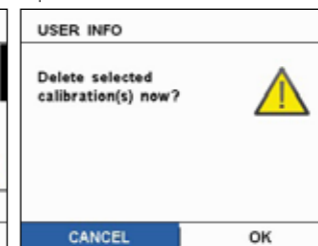
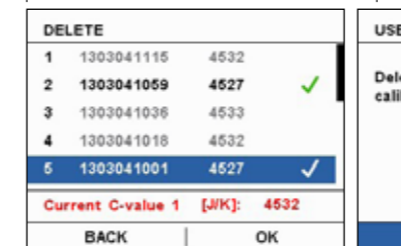

By clicking the "OK" button, the following user dialog appears:

By confirming with "OK", the selected calibrations will be deleted.

Default settings

DEFAULT SETTINGS	
C-value 1 [J/K]:	4532
ID IV1:	1
C-value 2 [J/K]:	0
ID IV2:	2
Ref. cal. value [J/g]:	25457
Ho Comb. cruc. [J/g]:	19839
CANCEL SAVE	

DEFAULT SETTINGS	
Ho Comb. cruc. [J/g]:	19839
Start temperature [°C]:	22.0
QExtern 1 [J]:	50
QExtern 2 [J]:	0
O ₂ rinse:	off
Cool Down:	on
CANCEL SAVE	

DEFAULT SETTINGS	
Start temperature [°C]:	22.0
QExtern 1 [J]:	50
QExtern 2 [J]:	0
O ₂ rinse:	off
Cool Down:	on
Extend. O ₂ Emptying [min]:	0
CANCEL SAVE	

- **C-value IB1; C-value IB2:**
C value for the corresponding inner vessel
- **ID IB1; ID IB2:**
Identification number of the inner vessel
- **Ref Energy:**
Calorific reference value of benzoic acid
- **H₀ Combustible crucible:**
Calorific value of the combustible crucible
- **Start temperature:**
Changing the mode of operation between 22 °C and 30 °C.
- **QExtern 1; QExtern 2:**
Default values for the external energies 1 and 2
- **O₂ rinse:**
The inner vessel can be rinsed (2x with subsequent filling) before the measurement of oxygen
- **Cool down:**
Cooling the system after measurement
- **Extend. O₂ Emptying [min]:**
0 - 99 adjustable

NOTE:

When using a gas-washing station, the ventilation time must be extended.

Settings

SETTINGS	
Date / Time	
Units	
Display / Keypad	
Language	
Accessories	
Chiller temperature	
BACK	

The setup menu contains the following menu items

- Date / Time
- Units
- Display / Keypad
- Language
- Accessories
- Chiller temperature

Date / Time

DATE / TIME	
Date:	04. March 2013
Time:	17:38:21
CANCEL SAVE	

Setting the system time and date.
This data is used for automatic generation of a new measurement name.

Units

UNITS	
J/g	
cal/g	
BTU/lb	
MJ/kg	
CANCEL SAVE	

The user can choose between the listed below unity representations:

- J/g
- cal/g
- BTU/lb
- MJ/kg

Display / Keypad

DISPLAY / KEYPAD	
Colour range:	white
Key tones:	yes
Animated menu:	yes
CANCEL SAVE	

The user can access this menu

- select and change the background color of the display. The background color can be selected either white or black
- the key tones on or off
- the appearance of the menus between animated view and list view move

Inverted menu view



Colour range black



Colour range white

List view

MENU	
Measurements	
Default settings	
Settings	
Maintenance	
Information	
28.02.2013	13:34:58

Language

LANGUAGE	
Deutsch (German)	✓
English	
中文 (Chinese)	
Italiano (Italian)	
Español (Spanish)	
Français (French)	
CANCEL SAVE	

Selecting the system language

LANGUAGE	
Italiano (Italian)	
Español (Spanish)	
Français (French)	
русский (Russian)	
日本語 (Japanese)	
Português (Portuguese)	
CANCEL SAVE	

Accessories

ACCESSORIES	
Heater:	off
Combustible crucible:	no
Printer:	off
Service info:	no
Balance:	off
CANCEL SAVE	

Selection of accessories

- **Heating:**
Use of heating during the measurement C 1.2
- **Combustible crucible:**
yes / no
Weight input of the combustible crucible in the submenu "New measurement" can be done manually or by data transfer from the balance.
- **Printer:**
Using a serial printer.
Selection option between:
 - off: no expression
 - briefly: expression
 - standard: result expression with temperature values
- **Service Information:**
Service information is outputted via the serial interface
- **Balance:**
Selecting a balance type.
Selection option between:
 - out
 - Sartorius/Kern
 - Mettler-Toledo
 - Ohaus

Chiller test

SETTINGS	
Date / Time	
Units	
Display / Keypad	
Language	
Accessories	
Chiller temperature	
BACK	

CHILLER TEST	
Actual temperature chiller: 19.7691	
Set temperature chiller: 20.6	
BACK	

Check whether the cooling water temperature within the specified range of
19.5 +/- 1.5 °C at the working temperature 22 °C

or

27.5 +/- 1.5 °C at the working temperature 30 °C

is located.

Maintenance

Maintenance menu:

The system must be open to performing the maintenance programs.

The maintenance menu can be reached at Menu > Maintenance and contains the following points

MAINTENANCE	
Change seal	
Test stirrer	
O ₂ System blow	
Servo up	
Servo down	
Do not close system!	
BACK	

Viewing maintenance programs that can be performed by the user at regular intervals.

Inner vessel and the inner vessel bottom lift out and set aside.

Change seal:

- 1 In the Menu Maintenance press "change seal" button. This requires oxygen pressure be present at C 1.
- 2 Unscrew the piston (Pos. 38 III) with screwdriver counterclockwise
- 3 Remove the O-ring (Pos. 38 VI)
- 4 Put new O-ring on piston (Pos. 38 VI)
- 5 Screw in piston and tighten securely
- 6 "Change seal" button again actuate pistons move to the home position

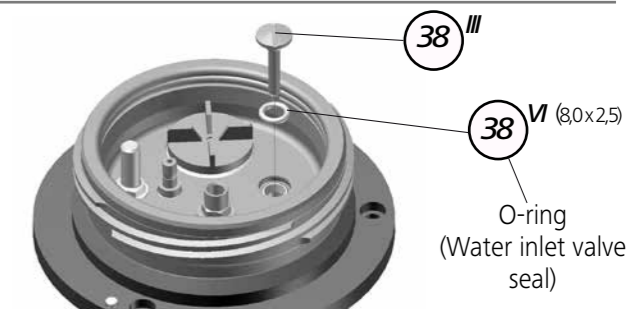

Stirrer test

The stirrer is switched on and off for a visual check.

O₂ System blow:

- 1 Lift out the inner vessel from the bottom and set aside
- 2 After about 20 seconds the button "O₂ system blow" button. Keep openings with a paper towel or similar covered by hand
- 3 After about 3 seconds, this state switches itself off again.

This any remaining condensed water and dirt is in the line blown out.

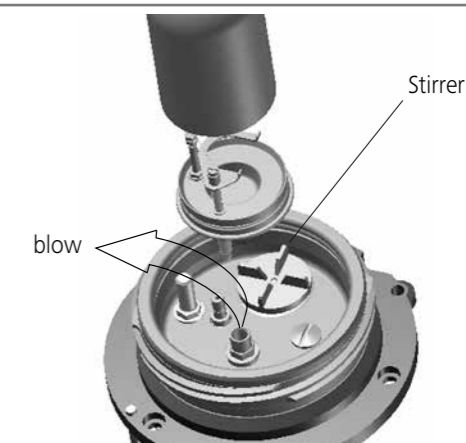

Servo up

The locking pin is extended.

Servo down

The locking pin is retracted.

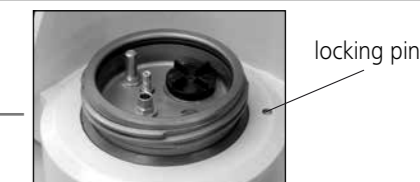

Informations

INFORMATION	
Software:	1.3 (28.02.2013)
Firmware:	0.99 (09.12.2011)
Serial number:	00.0000000
Service:	01.01.2011
Pressure test:	01.01.2011
Ignitions:	0
BACK	

INFORMATION	
Serial number:	00.0000000
Service:	01.01.2011
Pressure test:	01.01.2011
Ignitions:	0
Next test:	1000
Support:	www.ika.com
BACK	

This screen shows:

- the software and firmware version
- the serial number of the device
- the date of the last service
- the date of the last pressure test
- the number of performed ignitions
- the number of ignitions in the next pressure test must be performed
- the number of performed ignitions and support information
- IKA - Contact information

User information: Memory

Prior to input a new measurement

CHECK ARCHIVE MEMORY!			
Calib.	Curr.	Max	
IV1 22°C	14	15	⚠
IV1 30°C	0	15	
IV2 22°C	0	15	📱
IV2 30°C	0	15	
Meas.	30	100	
OK			

Information about the available space when you select the menu item "New Measurement"

This information is displayed when there is a value in the critical region is located, that is, from 95 out of 100 possible measurements in memory or from 13 of 15 calibrations in store for IB1, IB2 at 22 °C or 30 °C operating temperature.

After input a new measurement

USER INFO	
Archive is full. This measurement cannot be saved. Delete old measurements!	⚠
📱	
ARCHIVE	SKIP

After entering the values for a new measurement archive database will be checked again and if no free space is available following message is displayed:

Depending on the selection measurement or calibration, the screen sample will vary.

The user can skip this message, then the following measurement or calibration is not saved. However, it can also switch on the button "Archive" to the appropriate archive and then delete old or unused measurements or calibrations.

USER INFO	
Archive is full. This calibration cannot be saved. Delete unused calibrations.	⚠
📱	
ARCHIVE	SKIP

Exchanging of wear parts

O₂-Valve seal change

Use only original IKA spare parts!

- Bushing (Pos. 33) with the enclosed tool SW11 screw out
- Lift piston (Pos. 32/21) with tweezers
- Remove the O-ring (Pos. 40), insert a new O-ring and ensure the correct position
- Set piston (Pos. 32/21) back in the opening
- Bushing (Pos. 33) screw with the enclosed tool SW11 handtight, paying attention to correct position of the O-ring (Pos. 32/8)

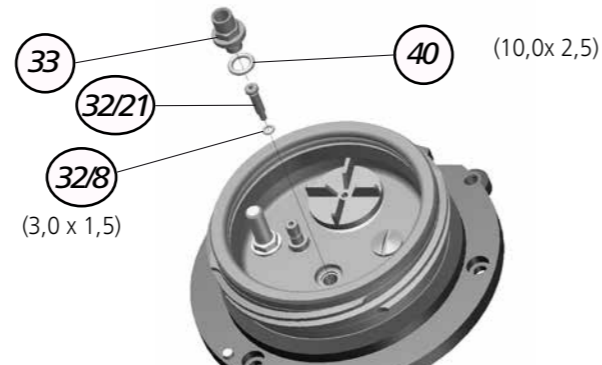

Change ignition wire

- To release the ignition wire (Pos. 24) on the ignition electrodes (Pos. 23) are both 6- hexagon nuts (Pos. 13) using spanner SW 5.5
- Turn down the upper nut (Pos. 13/1)
- To release the ignition wire to the ground electrode (Pos. 22) crucible holders hold hex nut (Pos. 13/3) and solve with spanner SW 5.5
- Screw (Pos.25) and remove while holding the crucible holder
- Remove old ignition wire and attach new ignition wire
- Ignition wire (Pos. 24) mounted as shown in figure on the screw (Pos.25)
- Screw in screw (Pos.25) into the crucible holder, screw hex nut (Pos.13/3) on the screw
- Complete unit (Pos. 25, 24,10,13) screw in the ground electrode, until the screw the ignition wire clamps
- Align the crucible holder, no contact to the ignition electrode, with hexagon nut on the ground electrode counter
- Align the lower nut on the ignition electrode (Pos.13/2) so that the ignition wire is horizontal
- Ignition wire (Pos. 24) on ignition electrodes (Pos. 23) mount
- Screw the upper hex nut (Pos. 13/1) and tighten the ignition wire with two nuts by counter holding the lower nut

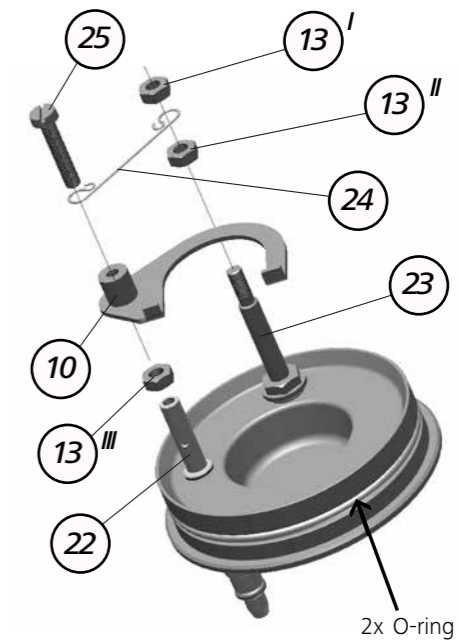

Safety note:
Use only original IKA spare parts!
In particular, the hex nuts (Hastelloy!)

Change ignition electrode

- Loosen ignition wire at the ignition electrode as described previously
- Hex nut (Pos. 12) and remove on the bottom of the inner vessel bottom (Pos. 2) loosen with the spanner and screw down SW7
- Ignition electrodes (Pos. 23) by pulling it upwards
- Take O-ring (Pos. 3) and replace with a new one
- Install new ignition electrode in reverse order, making sure that the insulating bushing (Pos. 6) located in the inner vessel bottom
- Tighten hex nut (Pos.12) by hand

Caution: Risk of short circuit at the nut is tightened too strong

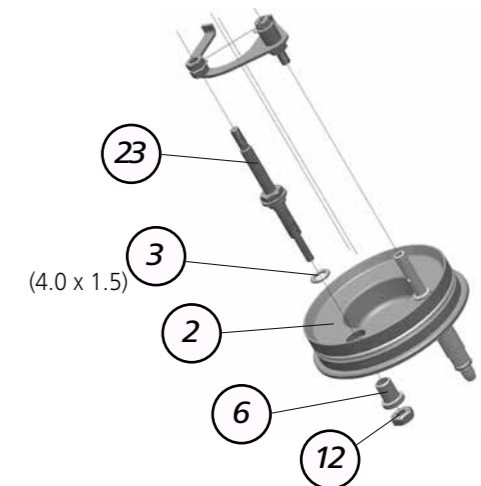

Change the main seal

- Remove O-ring with a suitable non-sharp tool

The O-ring can be removed with your fingers, pull the O-ring to two fingers apart, thus it is pulled out of the groove. Now it can be removed with your fingers.

Note: Rub the new O-ring before inserting it into the groove with O-ring grease (O-ring grease supplied).

This facilitates the closing of the C 1 considerably!

Upper part

Pos. 43 Quad-ring (92,0 x 4,5)



Inner vessel

Pos. 15 O-ring (48,0 x 2,0)



Marked with ★ rings must be greased as needed with the supplied grease.

1x X-ring ★

Change ground electrode

- 1 Loosen ignition wire as described above on the ground electrode
- 2 Unscrew the ground electrode (Pos. 22) with spanner SW 7
- 3 Remove and replace O-ring (Pos. 17) to mount the O-ring on the new ground electrodes
- 4 Screw in the new ground electrode
- 5 Install the new O-rings (Pos. 14) to the ground electrode

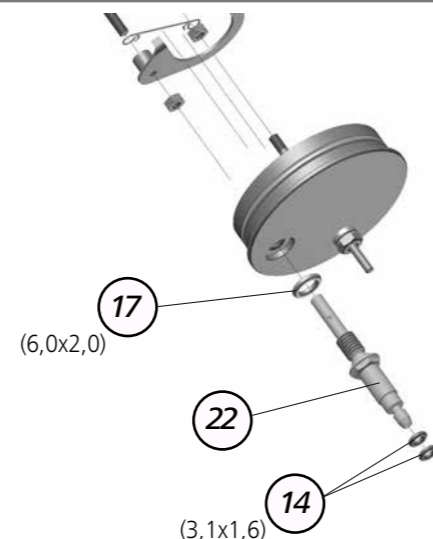

Leak test with the system test

Run a full system test to check for leaks:

- “Measurement” menu → menu “System test”.
- To perform a leak test with the system test, you must not use sample / calibration substance.
- Use the cotton thread to check whether the ignition electrode is correctly installed. The cotton thread is not burned. Reason could be a short to ground between the ignition electrode and the inner vessel bottom (e.g. by a wrong-mounted ignition wire).

Since no sample / calibration substance is used, breaks the system test with the error message “MINTEMPDIFF”.

The tightness test is passed if the cotton thread burned and the inner vessel is dry inside. No water should flow from the C 1.

Follow the instructions of the calorimeter!

Fault and troubleshoot

The calorimeter C 1 is subjected during the manufacture to stringent quality controls. Should any malfunctions occur, refer to the following section for a series of fault and error situations, the suitable remedial measures.

All disturbances and errors during measurement are displayed in a specific error window. There, the user receives a Circumstances of malfunctioning or error, and possible causes.

If your troubleshooting attempts is unsuccessful, contact your authorized from IKA Technical Service.

E01 STIRRER

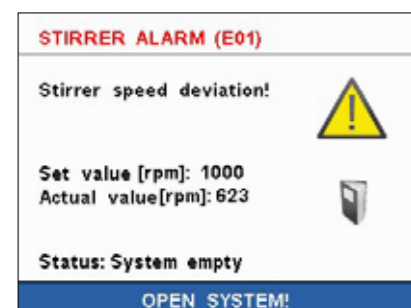

This error appears if the setpoint of the stirrer speed is not reached.

A possible cause for this problem is a defective stirring motor.

Check the stirring function, using the maintenance menu.

E02 COMMUNICATION



If no internal communication between the software and firmware are prepared COMMUNICATION ALARM appears..

E03 DRIFT ALARM

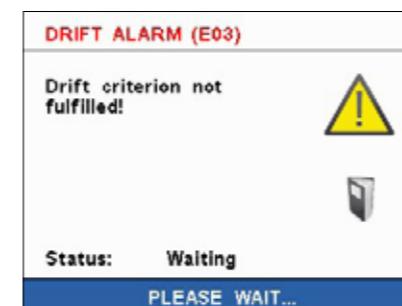

Drift Alarm

In preliminary experiment or or post-experiment the temperature drift criterion is not met.

Check the stirring function.

E04 MINTEMPDIFF

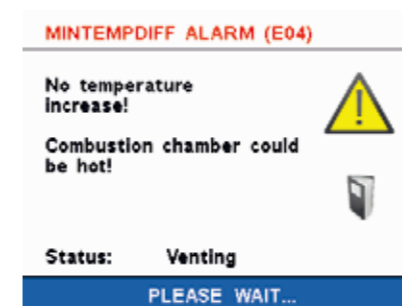

If 30 seconds is no temperature increase of 0.5 °C takes place after ignition, the alarm is displayed.

The most common causes for this problem are:

- the cotton thread is not in contact with the sample
- the contact with the fuse wire is not present due to contamination or an not properly tightened screw
- the bad combustibility the sample, optionally you must use firing aids
- Low oxygen pressure. Check the oxygen supply (30-40 bar)
- Short circuit at the ignition electrode, crucible holder is present at the ignition electrode

E05 FILLWATER

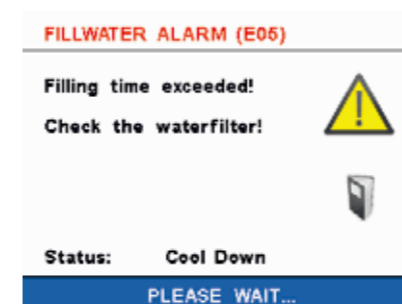

Message appears when the system during filling with water after 50 seconds does not detect water in the upper water outlet. Causes for this problem are:

- the cooler is not switched on or not connected
- Water valve seal defective
- no oxygen present (for switching the valves, the system requires pressure)
- upper water sensor is defective
- the filter in the supply line is dirty
- Water valve tightly or defective
- the water supply is not connect
- the water filter is clogged

E06 EMPTYWATER

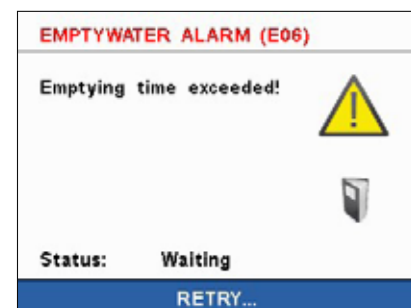

Occurs when the lower water sensor during the emptying of system after 60 seconds still detects water.

Possible causes for this problem are:

- the drain hose for sucking the air is in the water. Check the hose laying on the cooler (see page 8).
- the pump is defective. Switch the device off and back on and then run a system test. Disconnect the return flow line and let the water drain into a lower lying container..

E07 POSTWATERFILLING

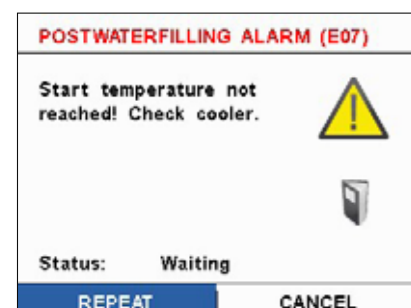

After 45 seconds in the post-water-filling state, the current temperature is compared with the selected fill-water temperature. If it falls below the Fill-water temperature, the oxygen filling is started.

Otherwise, the system additionally waiting 180 seconds, if the fill-water temperature is not reached.

A possible cause for this problem is set too high cooler temperature. Check the cooler.

E10 FILLWATER SENSOR



Water is detected too early in outlet.

The cause of this problem are water drops on the sensor.

contact this service.

E11 SYSTEM OPEN



System is not closed properly during an ongoing measurement.

- Contact closure defective!
- Locking can not engage.
- Twisted rotary handle.

E12 PRESSURE

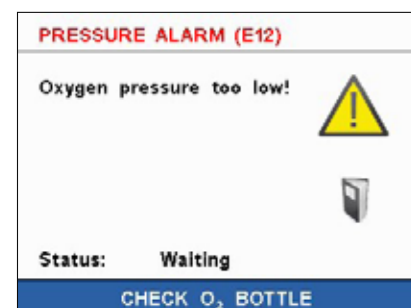

Oxygen pressure is too low (min. 20 bar).

The most common cause for this problem is an unopened or empty oxygen bottle.

Check the oxygen supply!

NOTE:

20 bar, the minimal pressure necessary to keep the system is able to work. A pressure < 30 bar may have measurement errors in consequence.

E13 HEATER

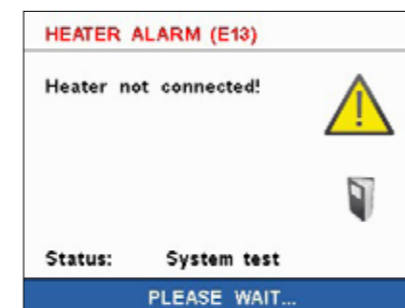

When using the heater C 1.20 this is not detected.

The most common cause for this problem is a switched off or unplugged heating during measurement.

Check the contact of the heating C 1.20.

E16 MAXTEMPDIFF



Temperature increase ≥ 10 °C detected.

Accessories and Consumables

C 6040	CalWin® software	C 1.104	Water bath additive
KV 600 d	Cooling water supply	C 5041.10	Connecting cable (for CalWin® C 6040)
C 1.10	Combustion chamber	C 1.101	Set of spare parts 1000
C 1.12	Combustion chamber, halogen resistant	C 25	Pressure regulating valve (when connected to water pipe above 1.5 bar)
C 1.12	Halogenresistent	•	Crucible holder
C 1.50	Dot-Matrix-Printer	•	Filter wrench
C 1.30	Venting station	•	Oxygen adapter China
C 1.20	Heater	•	Connecting cable PC/CalW./Kal-Mettler AE
C 21	Pelleting press	•	Connecting cable PC/Kal-Mettler AT, AM
C 29	Pressure gauge	•	Connecting cable PC/Kal-Mettler PR, PS, AG
C 4	Quartz dish	•	Connecting cable PC/CalWin®/Kal-Sartorius
C 6	Quartz crucible, big	•	Print ribbon RC-7000
C 5	Set of VA combustion crucibles	•	Printer paper for Star Printer SP712
C 710.2	Set of VA combustion crucibles	•	Serial printer cable for SP700
C 15	Paraffin strips		
C 16	Parafilm		
C 17	Paraffin		
C 9	Gelatine capsules		
C 10	Acetobutyrate capsules		
C 12 A	Combustion bags		
C 12	Combustion bags		
C 723	Benzoic acid, BIG Pack		
C 723	Benzoic acid, blister package		
C 710.4	Cotton thread		
C 1.103	Ignition wire		

Maintenance

Cleaning the water filter:



Clean the water filter in the water supply line every 2-3 days in the beginning and define the regular intervals, depending on the degree of contamination for cleaning.

Cleaning the combustion chamber:



Only use lint-free cloths for cleaning und drying! Cloth or paper lints clog the filter in the water supply line.

Thus, the flow rate is reduced and more error messages occur. This also affects the measuring accuracy!

The device is subject only to the natural wear and tear of components and their statistical failure rate. According to the **IKA** manufacturer specifications we recommend an annual maintenance with security check and pressure test according to Pressure Equipment Directive!

Cleaning:

- For cleaning disconnect the mains plug!
- Use only cleaning agents which have been approved by IKA to clean IKA devices:
 - These are water (with tenside) and isopropanol.
- When cleaning, please do not allow moisture to get into the unit.
- Wear the proper protective gloves during cleaning of the devices.
- Before performing a non-recommended method of cleaning or decontamination, the user must ascertain with **IKA** that this method does not destroy the instrument.

Spare parts order:

When ordering spare parts, please give:

- Machine type
- Serial number, see type plate
- Software Version (second displayed value when the device is on)
- Item and designation of the spare part please see www.ika.com.

Repair:

Please send instrument in for repair only after it has been cleaned and is free from any materials which may constitute a health hazard.

For this you should request the “**Decontamination Certificate**” from **IKA**, or use the download printout of it from the **IKA** website www.ika.com.

Return the instrument in its original packaging. Storage packaging is not sufficient. Also, please use suitable shipping package materials.

Warranty

In accordance with **IKA** warranty conditions, the warranty period is 12 months. For claims under the warranty please contact your local dealer. You may also send the machine directly to our factory, enclosing the delivery invoice and giving reasons for the claim. You will be liable for freight costs.

The warranty does not cover worn out parts, nor does it apply to faults resulting from improper use, insufficient care or maintenance not carried out in accordance with the instructions in this operating manual.

Technical data

Power supply unit (external)	
Design voltage /-frequency	100–240 V AC 50/60 Hz
Power consumption max.	120 W
Calorimeter:	
Design voltage	24 V DC 5A
Power consumption max.	120 W
Permissible duration of operation	100 %
Protection type acc. DIN EN 60529	IP 20
Protection class	I
Overvoltage category	2
Contamination level	II
Permissible ambient temperature	5–40 °C
Permissible relative humidity	80 %
Operation at a terrestrial altitude	max. 2000 m
Dimensions (W x D x H)	290 x 300 x 280 mm
Weight	15 kg
Measuring range (max.)	40,000 J
Mode of the measuring	isoperibol 22 °C isoperibol 30 °C
Measuring time	approx 7 min
Reproducibility (1g benzoic acid NBS39i)	0.15 % RSD
Working temperature	20–30 °C
Temperature measurement resolution	0.0001 K
Cooling medium temperature	19.5 K +/- 1.5 K for measuring mode isoperibol 22 °C 27.5 K +/- 1.5 K for measuring mode isoperibol 30 °C
Cooling medium permissible operating pressure	1.5 bar
Cooling medium	tap water / drinking water quality
Cool art	flow rate
Flow volume	50 ... 60 l/h
Oxygen operating pressure	30 ... 40 bar
Interfaces	RS232, USB-device

Subject to technical changes!

IKA

designed for scientists

IKA-Werke GmbH & Co. KG

Janke & Kunkel-Straße 10, 79219 Staufen, Germany

Phone: +49 7633 831-0, Fax: +49 7633 831-98

eMail: sales@ika.de

USA

IKA Works, Inc.

Phone: +1 910 452-7059

eMail: usa@ika.net

KOREA

IKA Korea Ltd.

Phone: +82 2 2136 6800

eMail: sales-lab@ika.kr

BRAZIL

IKA Brasil

Phone: +55 19 3772 9600

eMail: sales@ika.net.br

MALAYSIA

IKA Works (Asia) Sdn Bhd

Phone: +60 3 6099-5666

eMail: sales.lab@ika.my

CHINA

IKA Works Guangzhou

Phone: +86 20 8222 6771

eMail: info@ika.cn

POLAND

IKA Poland Sp. z o.o.

Phone: +48 22 201 99 79

eMail: sales.poland@ika.com

JAPAN

IKA Japan K.K.

Phone: +81 6 6730 6781

eMail: info_japan@ika.ne.jp

INDIA

IKA India Private Limited

Phone: +91 80 26253 900

eMail: info@ika.in

UNITED KINGDOM

IKA England LTD.

Phone: +44 1865 986 162

eMail: sales.english@ika.com

VIETNAM

IKA Vietnam Company Limited

Phone: +84 28 38202142

eMail: sales.lab-vietnam@ika.com

Discover and order the fascinating products of IKA online:
www.ika.com



IKAworlwide



IKAworlwide /// #lookattheblue



@IKAworlwide

Technical specifications may be changed without prior notice.

2000004724_EN_20005032f_C 1_032021